



AD20 ABSORBANCE DETECTOR OPERATOR'S MANUAL

© 1995 Dionex Corporation

Document No. 034853
Revision 03
April 1995

© 1995 by Dionex Corporation
All rights reserved worldwide
Printed in the United States of America

This publication is protected by federal copyright law. No part of this publication may be copied or distributed, transmitted, transcribed, stored in a retrieval system, or transmitted into any human or computer language, in any form or by any means, electronic, mechanical, magnetic, manual, or otherwise, or disclosed to third parties without the express written permission of Dionex Corporation, 1228 Titan Way, Sunnyvale, California 94088-3603 U.S.A.

DISCLAIMER OF WARRANTY AND LIMITED WARRANTY

THIS PUBLICATION IS PROVIDED "AS IS" WITHOUT WARRANTY OF ANY KIND. DIONEX CORPORATION DOES NOT WARRANT, GUARANTEE, OR MAKE ANY PRESENTATIONS REGARDING THE USE, OR THE RESULTS OF THE USE, OF THIS PUBLICATION IN TERMS OF CORRECTNESS, ACCURACY, RELIABILITY, CURRENTNESS, OR OTHERWISE. FURTHER, DIONEX CORPORATION RESERVES THE RIGHT TO REVISE THIS PUBLICATION AND TO MAKE CHANGES FROM TIME TO TIME IN THE CONTENT HEREINOF WITHOUT OBLIGATION OF DIONEX CORPORATION TO NOTIFY ANY PERSON OR ORGANIZATION OF SUCH REVISION OR CHANGES.

TRADEMARKS

DX LAN™ is a trademark of Dionex Corporation.
Teflon® and Tefzel® are registered trademarks of E.I. du Pont de Nemours & Co.

PRINTING HISTORY

Revision 01, August 1993
Revision 02, September 1993
Revision 03, April 1995

Contents

1 • Introduction

1.1	Overview	1-3
1.2	About This Manual	1-3
1.2.1	Typefaces	1-4
1.2.2	Safety Messages and Notes	1-4
1.2.3	Symbols	1-5
1.3	Related Manuals	1-6

2 • Description

2.1	Front Control Panel	2-4
2.1.1	Control Panel Keypad	2-5
2.2	Rear Panel	2-9
2.3	Electronics Chassis	2-10
2.4	Optical Chassis	2-13
2.4.1	Photodiode Assembly	2-14
2.4.2	Flow Cells	2-14
2.4.3	Heat Exchanger	2-15
2.4.4	Tungsten Lamp	2-15
2.4.5	Deuterium Lamp	2-16
2.5	Functional Description	2-17
2.5.1	Modes of Operation	2-17
2.5.2	Control	2-19
2.6	Theory of Operation	2-21

3 • Operation and Maintenance

3.1	Operating Guidelines	3-3
3.1.1	Wavelength Selection	3-3
3.1.2	Mobile Phases	3-3
3.1.3	Solvent Delivery System	3-4
3.2	Initial Screens	3-5
3.3	Running Under Direct Control	3-7
3.4	Running Under Method Control	3-8
3.4.1	Creating a New Method	3-9
3.4.2	Editing an Existing Method	3-10
3.4.3	Running a Method	3-12
3.4.4	Changing the Running Method	3-13
3.5	Controlling Another Instrument	3-13
3.6	DX LAN Remote Operation	3-13
3.7	Routine Maintenance	3-14

4 • Troubleshooting

4.1	No Detector Response	4-3
4.2	Noisy Baseline	4-4
4.3	Drifting Baseline	4-5
4.4	High Background Absorbance	4-6
4.5	Peaks Too Large or Small	4-7
4.6	Lamp Does Not Light	4-7
4.7	Detector Does Not Autozero	4-7
4.8	Cannot Calibrate Wavelength	4-8
4.9	Faulty DX LAN Communication	4-8

4.10 Diagnostics 4-9

5 • Service

5.1 Liquid Leaks 5-3
5.2 Cleaning the Cell 5-3
5.3 Removing Trapped Air from the Cell 5-4
5.4 Replacing the Main Power Fuses 5-4
5.5 Replacing the Deuterium Lamp 5-6
5.6 Replacing the Tungsten Lamp 5-7

A • Specifications

A.1 Electrical A-3
A.2 Environmental A-3
A.3 Physical A-3
A.4 Display and Keypad A-3
A.5 Detector A-4
A.6 Flow Cell A-5
A.7 Heat Exchanger A-5

B • Installation

B.1 Facilities Required B-3
B.2 System Configuration B-4
B.3 Unpacking B-5
B.4 Installation B-6
 B.4.1 Power B-6

AD20 Absorbance Detector

B.4.2	Flow Cell	B-7
B.4.3	Heat Exchanger	B-9
B.4.4	Waste Line	B-9
B.4.5	Detector Output	B-9
B.4.6	Relay/TTL Control	B-10
B.4.7	DX LAN Network Connection (Optional)	B-12

C • User Interface

C.1	Operational Screens	C-4
C.1.1	Menu of Screens	C-4
C.1.2	Main Screen	C-5
C.1.3	Detail Screen	C-7
C.1.4	Method	C-9
C.1.5	Module Setup Screen	C-11
C.1.6	Analog Output Setup	C-12
C.1.7	Time Function In	C-13
C.2	Diagnostic Screens	C-14
C.2.1	Diagnostic Menu	C-14
C.2.2	Power-Up Screen	C-15
C.2.3	Elapsed Time	C-16
C.2.4	Analog Status	C-17
C.2.5	DX LAN Status	C-19
C.2.6	Keyboard Test	C-21
C.2.7	Diagnostic Tests	C-22
C.2.8	Leak Sensor Calibration and Status	C-25
C.2.9	Signal Statistics	C-26
C.2.10	Offset Zero Calibration	C-27

D • Common Mobile Phases

D.1 Properties of Common Mobile Phases D-3

AD20 Absorbance Detector

1 • Introduction

- 1.1 Overview 1-3
- 1.2 About This Manual 1-3
 - 1.2.1 Typefaces 1-4
 - 1.2.2 Safety Messages and Notes 1-4
 - 1.2.3 Symbols 1-5
- 1.3 Related Manuals 1-6

AD20 Absorbance Detector

1 • Introduction

1.1 Overview

The AD20 Absorbance Detector is a dual-beam, variable wavelength photometer. Full spectral capability is provided by two light sources: a deuterium lamp for ultraviolet detection and a tungsten lamp for visible wavelength operation. The AD20 features programmable wavelength selection and automatic calibration for precision, reproducibility, and ease-of-use. The AD20 is designed for use with a variety of standard bore and microbore flow cells.

The AD20 can be controlled locally from the front panel, or from a remote host computer via the optional Dionex DX LAN interface and PeakNet Software.

1.2 About This Manual

Chapter 1, **Introduction**, provides a brief overview of the AD20 Absorbance Detector. It also includes an explanation of the product safety messages that appear throughout the manual.

Chapter 2, **Description**, describes physical aspects of the AD20, including front panel controls, electronics, and flow cells. This is followed by a description of the AD20 operating modes.

Chapter 3, **Operation and Maintenance**, discusses operating features and methods (how to create, edit, and run methods) and describes how absorbance detection is used. Routine preventive maintenance requirements appear at the end of this chapter.

Chapter 4, **Troubleshooting**, lists possible causes of problems, along with step-by-step instructions to isolate and eliminate them.

Chapter 5, **Service**, presents step-by-step instructions for routine service and parts replacement procedures.

AD20 Absorbance Detector

Appendix A, **Specifications**, lists the detector specifications and facility requirements.

Appendix B, **Installation**, describes the installation and interface required to place the AD20 into operation. Also included are setup procedures for operating the AD20 either in a stand-alone environment or as a component of a chromatography system.

Appendix C, **User Interface**, describes the front panel display and controls in detail and includes illustrations of all menus and screens used for AD20 operation and diagnostics.

Appendix D, **Common Eluents**, lists the UV cutoff values (in nm) for selected absorbance eluents.

1.2.1 Typefaces

Typefaces are used in this manual as follows.

- Capitalized bold Helvetica indicates a front panel button:
Press **Enter** to begin running the method.
- Upper-case bold Helvetica indicates the name of a menu or screen; it may also indicate a field on a screen:
Go to the **METHOD** screen.
Move the cursor to the **EDIT** field.

1.2.2 Safety Messages and Notes

This instrument has been designed to comply with the requirements for safety set forth in IEC 1010 *Safety Requirements for Electrical Equipment for Measurement, Control, and Laboratory Use*.

This manual contains warnings and precautionary statements that can prevent personal injury and/or damage to the instrument when properly followed. Safety messages appear in bold type and are accompanied by icons.



Indicates a potential hazard which could result in serious injury or loss of life. Any hazard of this type will be located behind a barrier and will be accessible only by use of a tool. Access may be required during installation, maintenance, or service.



Indicates a potential hazard to the operator, or damage to the instrument or other property.



Indicates that the function or process of the instrument may be impaired. Operation does not constitute a hazard.

Informational messages also appear throughout this manual. These are labeled NOTE and are in bold type:

NOTE

NOTES call attention to certain information. They alert you to an unexpected result of an action, suggest how to optimize the performance of the instrument, etc.

1.2.3 Symbols

The symbols below appear on the detector, or on detector labels.

~ Alternating current



Protective conductor terminal

AD20 Absorbance Detector

 Power supply is on

 Power supply is off

1.3 Related Manuals

During installation and operation of the AD20, you may need to refer to one or more of the following manuals (depending on your system) for information about other modules and components included in a DX 500 system.

The following manuals are provided with their respective products:

LC10 Chromatography Organizer Operator's Manual (Document No. 034858)

LC20 Chromatography Enclosure Operator's Manual (Document No. 034859)

LC30 Chromatography Oven Operator's Manual (Document No. 034860)

GP40 Gradient Pump Operator's Manual (Document No. 034856)

IP20 Isocratic Pump Operator's Manual (Document No. 034857)

PeakNet Software User's Guide (Document No. 034914)

The following manual is provided in the AD20 Ship Kit:

Installation of Dionex Ferrule Fittings (Document No. 034213)

2 • Description

2.1	Front Control Panel	2-4
	Screen Contrast	2-4
	Tilt Panel	2-4
	Power Switches	2-4
2.1.1	Control Panel Keypad	2-5
2.2	Rear Panel	2-9
	Power Entry	2-9
	Fuses	2-10
	DX LAN Connection (Optional)	2-10
2.3	Electronics Chassis	2-10
	Power Supply Card	2-11
	PIO (Power) Card	2-12
	SPI (Signal Processing) Card	2-12
	Blank Card	2-12
	Relay/DX LAN and CPU Cards	2-13
2.4	Optical Chassis	2-13
	Leak Management	2-14
2.4.1	Photodiode Assembly	2-14
2.4.2	Flow Cells	2-14
2.4.3	Heat Exchanger	2-15
2.4.4	Tungsten Lamp	2-15
2.4.5	Deuterium Lamp	2-16
2.5	Functional Description	2-17
2.5.1	Modes of Operation	2-17
	Local Mode	2-17
	Remote Mode	2-18

AD20 Absorbance Detector

2.5.2	Control	2-19
	Direct control	2-19
	Method control	2-19

2 • Description

The AD20 Absorbance Detector consists of two single-unit DX 500 enclosures (see Figure 2-1). The upper unit houses the detector electronics, while the lower unit houses the optical chassis.

The AD20 is designed to be stacked on top of other DX 500 modules. Figure B-1 in Appendix B illustrates the recommended stacking configuration for DX 500 systems.

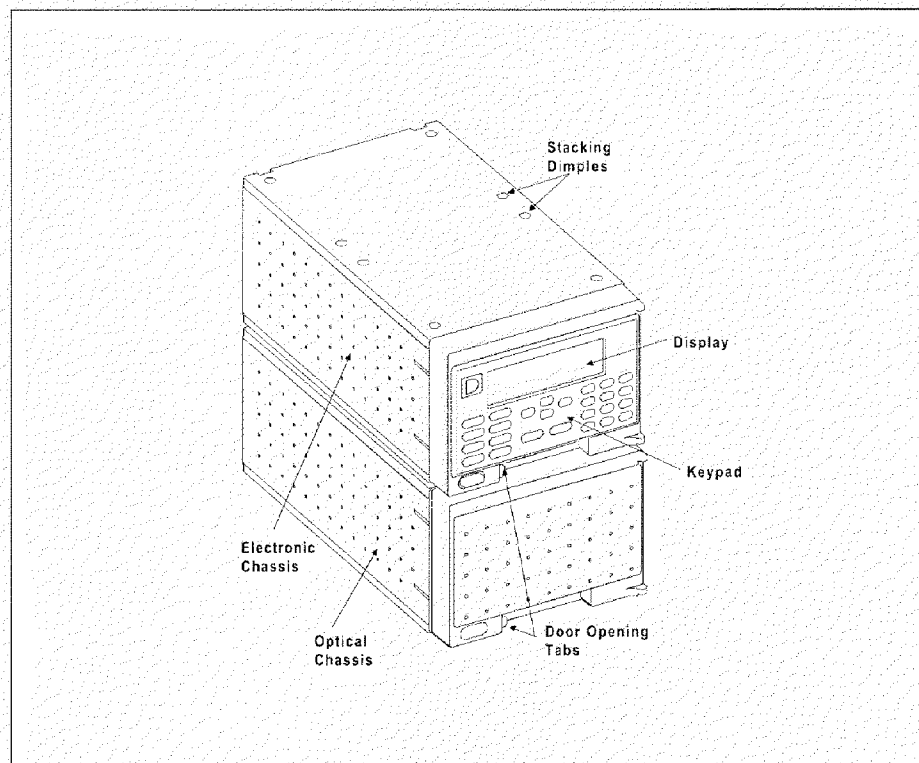

Figure 2-1. AD20 Absorbance Detector

AD20 Absorbance Detector

2.1 Front Control Panel

The control panel on the upper door of the AD20 enclosure contains the liquid crystal display (LCD), the membrane keypad, and the actuator for the main power switch. The door opens to provide access to the detector electronics, which are described in Section 2.3.

Screen Contrast

Information is displayed on the LCD, also called the *screen*, in white letters on a blue background. To adjust the screen contrast, use the knurled knob in the recess below the **Help** and **Menu** buttons (see Figure 2-2).

Tilt Panel

To maximize visibility, the front control panel can be tilted to four different positions.

- To tilt the panel, support the door at the left side (to prevent it from opening) and lift firmly on the tab in the recess below the **Help** and **Menu** buttons (see Figure 2-2).
- Push on the tab to return the panel to its vertical position.

Power Switches

The main power switch is on the bulkhead *behind* the upper door. An actuator for the main power switch is on the outside of the door, at the lower left corner (see Figure 2-2). The actuator functions only when the door is fully closed. When the door is open, press the main power switch on the bulkhead to turn the AD20 on and off.

2.1.1 Control Panel Keypad

The front panel keypad (Figure 2-2) is used to control detector operation directly, as well as to create and modify programmed series of timed events, called *methods*.

- Pressing **Menu** displays a list of screens available for display.
- Only the fields shown in reverse video on a screen can be edited—the other fields are informational displays.
- Use the four directional arrow buttons to move the cursor to an editing field. Use the numerical buttons to enter a variable value in the field; use the **Select** Δ and **Select** ∇ buttons to choose from predetermined options. Pressing a **Select** button increases (or decreases) a numerical value by one, while holding down either of the **Select** buttons increases (or decreases) the numerical value continuously.
- Pressing **Enter** executes the selected value.
- A beep sounds each time you press a front panel button. When an error occurs, this beep is lower in frequency. The beeps can be disabled from the **MODULE SETUP** screen.

Offset

Returns the analog (recorder) output to a predetermined baseline and zeros the display. The resultant value of the offset required is displayed on the **DETAIL** screen. This function can be programmed in a method.

Mark

Sends a 10% positive event mark to the analog (recorder) output. (A mark is typically used to indicate a sample injection.) This function can be programmed in a method.

AD20 Absorbance Detector

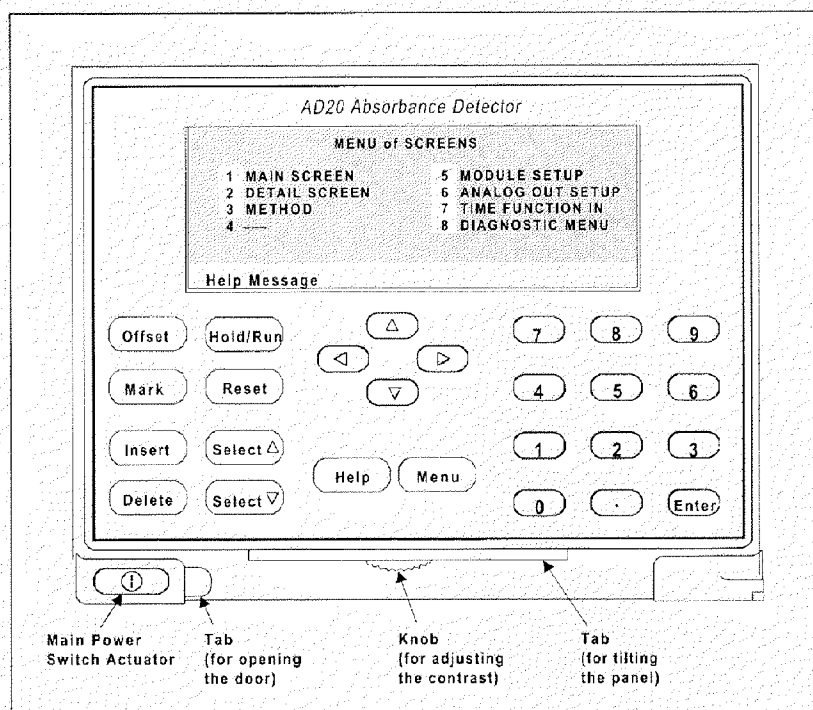

Figure 2-2. AD20 Front Panel

Insert

Inserts a new step into a method. Move the cursor to the **TIME** field and press **Insert** to add a new step after the cursor position. The parameter fields in the new step will be blank. Enter a time value for the new step and press **Enter**. (If you move the cursor to a different field before entering the time, the new step is incomplete and will disappear.)

Insert steps in any order; after you press **Enter**, the steps will be automatically organized in the correct chronological order.

Delete

Removes the value from the current entry field, allowing entry of a new value. To restore the previous value, move the cursor from the field without entering a new value.

On the **METHOD** screen, pressing **Delete** when the cursor is in a step entry field “blanks” the step parameter value. When you move the cursor from the field, the field remains blank (i.e., the previous value is not restored, as it is on other screens). Blank step fields indicate that there is no change from the previous step.

To use **Delete** to delete an entire method step:

1. Position the cursor in the method’s time field and press **Delete**. The time is removed and the help line displays this message:

TO DELETE THIS STEP, PRESS DELETE AGAIN

2. To delete the entire step, press **Delete** again. If you do not want to delete the step, press any button except **Delete** and the original time and step parameters will be restored.

Hold/Run

Turns the method clock off (**Hold**) and on (**Run**). This button functions only when the detector is under Method control (see Section 2.5.2).

When the method clock is in Hold, pressing **Hold/Run** starts the clock. The clock starts at the initial step of a new method or, if resuming an interrupted method, at the time at which the clock was put in Hold.

When the method clock is in Run, pressing **Hold/Run** stops the method clock, thereby “holding” the method and freezing the current conditions.

AD20 Absorbance Detector

Reset

Changes the method clock time to **INIT**, causing the initial conditions specified by the method to occur. This button functions only when the detector is under Method control (see Section 2.5.2).

If the method is running, it continues running. If the method is in Hold, the method clock executes the initial conditions and holds.

Select Δ and **Select ∇**

When the cursor is positioned at a field with predetermined parameters, these buttons cycle through the options. In fields which have predetermined numerical values, pressing **Select Δ** increases the value by one unit, while pressing **Select ∇** decreases the value by one unit. Holding down one of the **Select** buttons increases (or decreases) the value continuously. Press **Enter** to place the new value into effect.

←, ↑, →, and ↓

The four cursor directional buttons move the cursor, in the direction of the arrow, to the next entry field. If there is no changeable field in that direction, the cursor moves diagonally or remains where it is.

Help

Displays a help screen with information pertaining to the current entry field.

Menu

From any operational screen, pressing **Menu** displays the **MENU of SCREENS**. From any diagnostic screen, pressing **Menu** once returns you to the **DIAGNOSTIC MENU**; pressing **Menu** again returns you to the **MENU of SCREENS**.

Numeric Buttons

Enters numeric values into the current entry field. The numeric buttons are 0 through 9 and the decimal.

Enter

Saves and/or executes changes made in entry fields. After pressing **Enter**, the cursor moves back to the left margin of the same field. It does not automatically move to the next field.

On menu screens, pressing **Enter** displays the highlighted screen.

On the **METHOD** screen, pressing **Enter** does not save changes to method parameters. To save editing changes, move the cursor to the **SAVE TO** field, enter the method number, and press **Enter**.

2.2 Rear Panel

The AD20 rear panel (Figure B-3) contains fuses, connectors for line power, and the optional DX LAN connector.

Power Entry

The power entry, fusing, and EMI filter are mounted on the rear of the 150 watt power supply module. The power entry is socketed for a modular power cord (IEC 320 C13). The detector requires a grounded, single-phase power source. The detector may be operated from 85 to 270 Vac, 47 to 63 Hz power. The input power is 150 watt maximum. The line voltage is automatically selected and requires no adjustments.



SHOCK HAZARD—If a grounded receptacle is not used, a shock hazard may result. Do not operate or connect to AC power mains without earthed ground connections.

AD20 Absorbance Detector

Fuses

The AD20 uses two 3.15 A slow-blow fuses (IEC 127 type 1, P/N 954745). See Section 5.4 for instructions on replacing the fuses.



WARNING

For continued protection against risk of fire or shock, replace with the same type and rating fuse.

DX LAN Connection (Optional)

When you order the DX LAN network, a standard BNC connector is factory-installed in the upper left corner of the AD20 rear panel.

NOTE

In order to use PeakNet Software to control AD20 operation via the DX LAN, a detector interface card (P/N 044196) must be installed in the AD20 (see Section B.4.7).

2.3 Electronics Chassis

The electronics chassis is located immediately behind the front door of the upper unit of the AD20 enclosure. The chassis includes the electronic cards (printed circuit boards), TTL and Relay connections, and analog (recorder) connections. Figure 2-3 shows the position of the electronics components.

Connections to the front of the electronics modules, such as TTL and relay cables, are routed to the back of the AD20 through the cable chase in the bottom of the electronics chassis. Cables exit the AD20 through an opening in the upper unit of the enclosure.



WARNING

Do not remove any of the electronic cards from the detector. There are no user-serviceable components on these cards. If servicing is required, it must be performed by qualified personnel following appropriate electrostatic discharge (ESD) handling procedures.

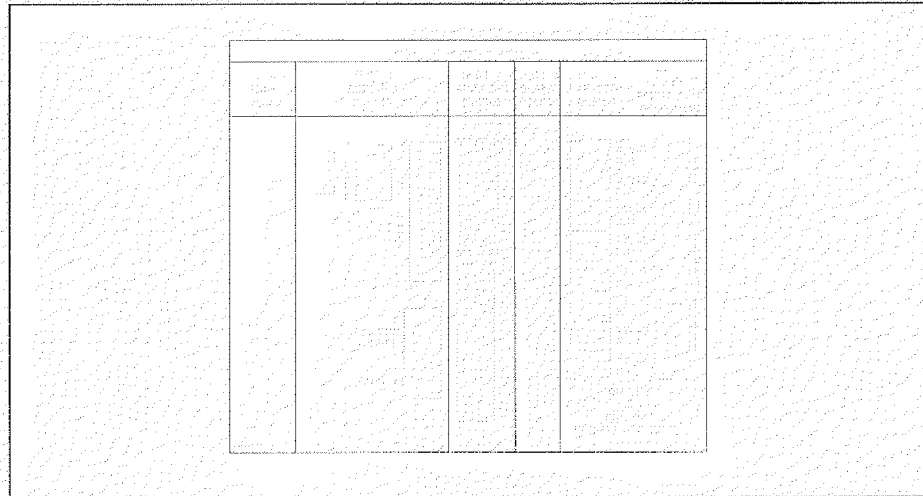

Figure 2-3. AD20 Electronics Chassis Components

Power Supply Card

The Power Supply card contains the connections to the AC mains. It provides regulated low voltage power for the AD20. Power entry components are shielded and filtered to prevent electromagnetic interference (EMI). The power supply is rated at 150 W. The power switch is at the lower front edge of the Power Supply card.



SHOCK AND FIRE HAZARD—The power supply module operates at line potentials. Refer all servicing to qualified personnel.

AD20 Absorbance Detector

PIO (Power) Card

The PIO card controls the deuterium and tungsten lamps, the grating drive motor, and the filter/shutter wheel. It also supplies power to the optical unit cooling fans.



SHOCK HAZARD—Components used for the deuterium lamp ignition and operation are at high potentials. Refer all servicing to qualified personnel.

SP1 (Signal Processing) Card

The SP1 card provides the signal processing used when absorbance is measured. A pre-amp in the optical chassis is connected to the SP1 card via a 25-pin D sub-miniature connector and a ribbon cable. The photodiode outputs are amplified for subsequent log ratio conversion to absorbance by the pre-amp. The gain of the pre-amp is variable to compensate for the lamp output and other system variables. The pre-amp does not require calibration.

The 3-pin connector at the top of the SP1 card is the analog (recorder) output. The output scale, polarity, baseline offset, and filter rise time can be set from the **ANALOG OUT SETUP** screen.

Blank Card

The slot next to the SP1 card contains a blank card. This card completes the electromagnetic interference (EMI) shielding.

Relay/DX LAN and CPU Cards

The AD20 control Moduleware and BIOS reside on the CPU logic and Relay I/O cards in slot 5 of the card cage. The Relay card rides piggyback on the CPU card and extends over the front of slot 4.

A 60-pin ribbon cable assembly links the CPU logic to the front panel display and keypad. The CPU logic monitors the internal power supply outputs. The multicolor LED at the bottom of slot 4 indicates the status of the power supply:

- A green LED indicates normal operation.
- A red or yellow LED indicates a power fault. If a power fault occurs, the AD20 enters its diagnostic state and no other control is permitted until the fault is corrected.

The Relay card is short enough to allow an optional DX LAN detector interface card (P/N 044196) to be mounted behind it in slot 4. If you have a PeakNet Workstation, you can download Moduleware updates from PeakNet Software.

2.4 Optical Chassis

The optical chassis is located immediately behind the front door of the lower unit of the AD20 enclosure. The chassis contains the optical hardware, flow cell, and photodiode assembly. The optical bench and cooling components are mounted in a drawer. The drawer slides out of the enclosure to permit routine servicing without breaking down the system.

The drawer is on a track with detent stops. To open the drawer, lift the grip handle at the front of the drawer to clear the first detent. A second detent stops the drawer when it is halfway out.



Do not open the optical chassis drawer past the second detent.

AD20 Absorbance Detector

Leak Management

Because the flow cell is behind the detector front door, liquid leaks may not be detected immediately. To prevent damage to detector components, a leak tray is built into the bottom of the optical chassis. A sensor in the sump of the leak tray responds to changes in thermal dissipation when wet and triggers an alarm in the detector. If the AD20 is connected to a PeakNet Workstation via the DX LAN interface, an alarm signal is sent to PeakNet Software.

Tubing connected to the rear of the leak tray directs leaks into a waste container. Check periodically to verify that the drain tube is not clogged and that it is routed below the leak tray.

2.4.1 Photodiode Assembly

The photodiode assembly is mounted directly on the cell and beamsplitter, allowing a variety of flow cell options (see Section 2.4.2). The signal cable connects to the pre-amp behind the bulkhead panel.

2.4.2 Flow Cells

Flow cells, which are ordered separately from the AD20, are available in the following path lengths and volumes:

- Standard bore—10 mm path, 9 μ L volume, PEEK
- Narrow bore—6 mm path, 7.5 μ L volume, PEEK
- Microbore—3 mm path, 2.5 μ L volume, PEEK

The cell may be operated at pressures up to 3.45 mPa (500 psi) if operated without the heat exchanger. See Section 2.4.3 for more information about the heat exchanger.



Do not use a PEEK cell with applications employing normal phase or chlorinated solvents; these solvents will damage the cell.

2.4.3 Heat Exchanger

The heat exchanger is a knitted coil that smooths the baseline during trace-level analyses by minimizing fluctuations in cell and flow stream temperature that cause drift and noise.

The heat exchanger is mounted just below the flow cell. The appropriate heat exchanger is included with the flow cell.

Description	Volume	Materials
Standard bore	10 μ L	Tefzel, PEEK
Microbore	2 μ L	Tefzel, PEEK



Do not operate the heat exchanger at backpressures greater than 1.38 mPa (200 psi). For applications that require extremely low dead volume, or have very high backpressure after the detector, you may bypass the heat exchanger.

The heat exchanger contains indium (In) alloy. If the heat exchanger is ever damaged, dispose of it in accordance with local laws.

2.4.4 Tungsten Lamp

The tungsten lamp (P/N 047426) is a halogen lamp that provides high quality visible and near-UV performance. At the low power setting, the lamp provides good visible and near-IR performance.

The lamp is socketed on a detachable mount at the right rear of the optical chassis. Replacement lamps are pre-aligned to the detachable mount. The tungsten lamp has a service life of 1000 hours when routinely operated at high power, or 5000 hours when routinely operated at low power.



The lamp housing may be hot to the touch, especially when the lamp has been operating on high. Allow 5 minutes for the lamp housing to cool before handling.

AD20 Absorbance Detector

2.4.5 Deuterium Lamp

The deuterium lamp (P/N 045230) is sealed in a pre-aligned mount and is clamped to the side of the monochromator. An alignment pin in the optical chassis registers the position of the lamp assembly for simple replacement.

The deuterium lamp has a service life of 1000 hours when routinely operated at high power, or 2000 hours when routinely operated at low power.



The lamp housing may be hot to the touch, especially when the lamp has been operating on high. Allow 5 minutes for the lamp housing to cool before handling.

2.5 Functional Description

This section discusses the AD20 Absorbance Detector functional operation, including operating modes and types of control.

2.5.1 Modes of Operation

The AD20 has two operating modes: *Local* and *Remote*. When the detector is powered up, it is always in Local. To change the operating mode, go to either the **MAIN** or **DETAIL** screen. There, move the cursor to the **LOCAL** field and use the **Select Δ** or **Select ∇** button to toggle the mode. Press **Enter** when the mode is correctly selected. When you select **REMOTE**, you will be prompted to confirm the selection.

Local Mode

Local mode allows two types of commands:

- Direct entry onto a screen, using the front panel buttons
- TTL and Relay inputs

TTL functions are defined from the **TIME FUNCTION IN** screen. TTL logic levels can control any four of these AD20 functions:

- OFFSET
- HOLD/RUN
- LAMP OFF/ON (for both lamps)
- METHOD NUMBER INCR
- METHOD NUMBER DECR
- MARK Recorder
- Increase RANGEX10

This allows control of the AD20 via a remote controller or the timed event function of an integrator. The remaining functions are controlled from the AD20 front panel buttons.

AD20 Absorbance Detector

You may configure input TTL logic levels as normal edge, inverted edge, normal pulse, or inverted pulse. No special setup or switch is required for TTL control, which is always available in Local mode. Front panel control remains active.

Remote Mode

NOTE

For more information about Remote control of the detector, refer to the *PeakNet Software User's Guide*.

In Remote mode, the AD20 is computer-controlled through PeakNet Software and the DX LAN interface. Select the Remote mode from the **MAIN** or **DETAIL** screen, or from PeakNet.

There are two forms of Remote control: Remote and Locked Remote. While operating in normal Remote mode, all buttons on the AD20 front panel function except **Hold/Run**. **Enter** can be used to select display functions that do not interfere with DX LAN remote control of a method while it is running.

The Locked Remote mode locks out all parameter changes from the AD20 front panel. Locked Remote can be selected only from the computer and can be cleared only from the computer or by turning off the AD20 power. When the AD20 is powered up again, it will be in Local mode.

If you select the Remote mode while the AD20 is running a method, the computer will not interrupt the method unless you select the Abort command from PeakNet Software.

After PeakNet downloads a method to the AD20, the computer activates the method number with a DX LAN command. The **INITIAL** conditions step is activated. If a method is already running when the computer activates a method number, that method will be interrupted and the detector method clock will reset to **INITIAL** conditions.

A subsequent Run command will cause the AD20 method clock to run, activating the timed event starting with the time 0.00 step of the method.

2.5.2 Control

There are two types of control in either Local or Remote mode: *Direct* control and *Method* control.

Direct Control

In Direct control, commands are executed as soon as they are entered. Since there is no time-based program, the method clock is not used. The **Hold/Run** and **Reset** buttons are not operable in Direct control.

To select Direct control, first go to either the **MAIN** or **DETAIL** screen. If **DIRECT CNTRL** is displayed, the mode is already selected and no further action is necessary. If **METHOD** is displayed, move the cursor to **METHOD** and press the **Select Δ** or **Select ∇** button to toggle between **DIRECT CNTRL** and **METHOD** in the display. Press **Enter** to activate the selection.

If a method is running when you select Direct control, that method is aborted and the method clock is reset.

Method Control

In Method control, commands are executed as programmed in a given method. The parameters below are method-controlled and cannot be changed from the AD20 front panel:

- Analog range
- Offset
- Mark
- Wavelength
- Lamp settings
- Relays and TTLs

AD20 Absorbance Detector

There are three ways to change a method-controlled parameter:

- Edit the currently running method and save the changes. The changes will be implemented when the method is saved.
- Switch to a different method.
- Abort the method, go to Direct control, and enter the new parameters directly.

Methods are programmed and controlled from the **METHOD** screen. Besides storing and running methods, the AD20 allows you to run the detector under Method control while you are editing any method, even one that is currently running.

When saving changes to the currently running method or switching to a different method, the method clock continues running unaffected. Only those parameter changes which affect the method *after* the current time will be implemented in the current run. Of course, you may intentionally press **Reset** to implement the initial conditions.

You may enter non-method programmed parameters from the front panel, as well as display screens to monitor detector operation.

To select Method control while in Direct control, go to either the **MAIN** or **DETAIL** screen. Move the cursor to the **DIRECT CNTRL** field, press either **Select** button, and press **Enter**. **METHOD** will replace **DIRECT CNTRL** in the display.

Each method can contain up to 32 separate time-based steps, starting at time zero (**TIME = 0**). A method is created by first selecting a method number from 0 through 99. The steps are then entered one-by-one by entering first the time and then whatever operating parameters you want to be in effect at that time.

Methods are retained in memory even after the detector power is turned off. Up to 100 methods (00 through 99) can be stored in AD20 memory. The actual total depends on the size of each method and the amount of available memory and is usually less than 100.

2.6 Theory of Operation

Photometric detection is based on the absorption of monochromatic light. The degree of absorption depends on the sample molecule, its concentration, the sample path length, and the wavelength.

The definition of absorbance is Beer-Lambert's Law:

$$A = \epsilon c l = \log_{10} \left(\frac{I_r}{I_s} \right) \quad \text{and is dimensionless}$$

where:

- ϵ = molar absorptivity of the sample ($L \cdot \text{mol}^{-1} \cdot \text{cm}^{-1}$)
- c = concentration (mol/L)
- l = cell path length (cm)
- I_r = reference beam intensity
- I_s = sample beam intensity

Detection can be made by direct native absorption of a chromophore in the sample, or by indirect and post-column reactions. For a list of wavelengths for the absorption maxima of various chromophores, see Appendix D.

Each lamp illuminates the monochromator filter wheel/shutter when it is turned on (see Figure 2-4). The shutter allows passage of light at the selected wavelength. It also incorporates second-order and wavelength calibration filters for visible operation.

A concave holographic diffraction grating disperses the light and focuses the wavelength required. The monochromator exit is made by a bifurcated fiber-optic which generates the sample and reference optical beams. The reference beam is imaged directly to a photodiode detector and the reference intensity is measured. The

AD20 Absorbance Detector

sample beam is imaged to the flow cell, and the resultant sample intensity is measured. Absorbance measurement is completed by the pre-amp and the SP1 electronics.

NOTE

An excellent reference for the principles used to take the best advantage of photometric detection is the text *Biological Spectroscopy* by Ian D. Campbell and Raymond A. Dwek, published by The Benjamin/Cummings Publishing Company, Inc. (ISBN 0-8053-1849-6).

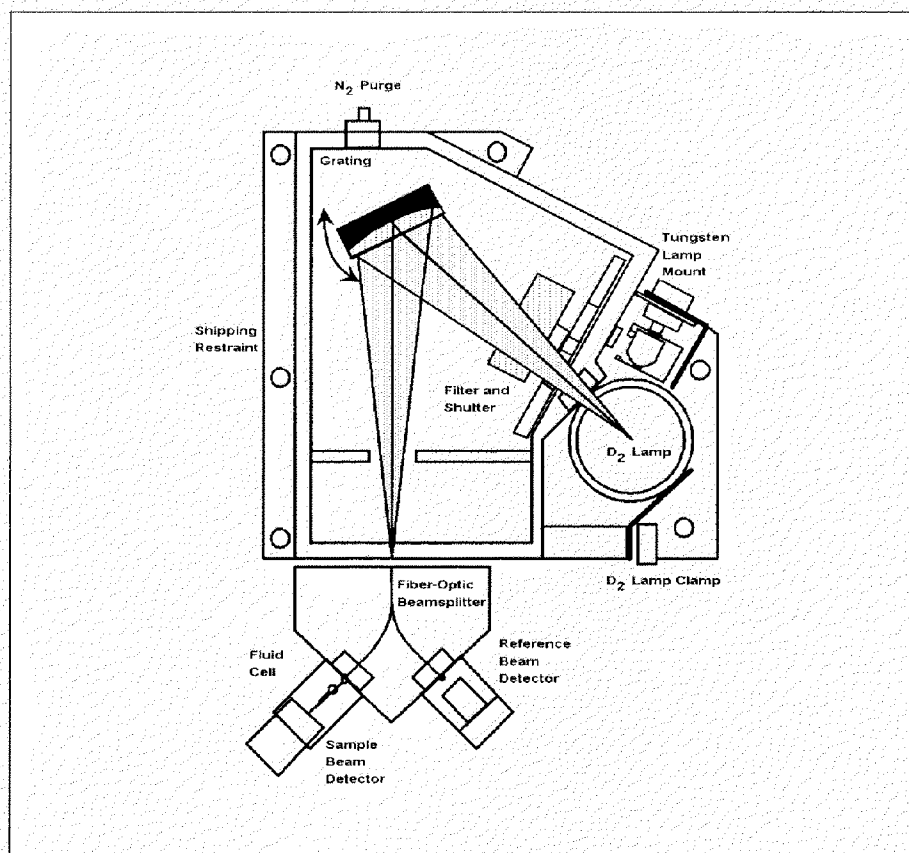

Figure 2-4. Optical System

3 • Operation and Maintenance

3.1	Operating Guidelines	3-3
3.1.1	Wavelength Selection	3-3
3.1.2	Mobile Phases	3-3
3.1.3	Solvent Delivery System	3-4
3.2	Initial Screens	3-5
	Power-Up Test	3-5
	Power-Up Screen	3-6
	Diagnostic Tests Screen	3-6
	Main Screen	3-7
3.3	Running Under Direct Control	3-7
3.4	Running Under Method Control	3-8
3.4.1	Creating a New Method	3-8
3.4.2	Editing an Existing Method	3-10
	Changing Method Parameters	3-11
	Adding a Method Step	3-11
	Deleting a Method Step	3-11
	Deleting an Entire Method	3-11
	Saving a Modified Method	3-12
3.4.3	Running a Method	3-12
3.4.4	Changing the Running Method	3-13
3.5	Controlling Another Instrument	3-13
3.6	DX LAN Remote Operation	3-13
3.7	Routine Maintenance	3-14

AD20 Absorbance Detector

3 • Operation and Maintenance

3.1 Operating Guidelines

3.1.1 Wavelength Selection

There are two major criteria for determining the wavelength for an analysis:

- Sample components should absorb strongly at the selected wavelength.
- The mobile phase should be “transparent,” showing little or no absorption, at the selected wavelength.

For a list of wavelengths for the absorption maxima of various chromophores, refer to Appendix D.

3.1.2 Mobile Phases

Solvent quality significantly affects detection limits and instrument performance. To ensure optimal performance of the AD20 Absorbance Detector, follow these precautions:

- Prepare all mobile phases with spectroscopy-grade solvents, reagent-grade chemicals, and ASTM Type I (or better) filtered deionized water.
- Degas all mobile phases before use and maintain them in a degassed state.
- Strong bases will etch silica. If the mobile phase is a base and the flow cell windows are silica, the mobile phase concentration should not exceed 0.1 M. If the concentration of the base is greater than 50 mM, disconnect the separator column and flush the system with deionized water for 5 minutes at 1.0 mL/min immediately after the analysis.

AD20 Absorbance Detector

- Mobile phase pH affects not only the retention time of the separation, but the absorbance of the sample and the background absorbance of the mobile phase. If an analysis employs chemical suppression and compound detection techniques, compare the UV cutoff of the eluent before and after the suppressor to see whether it is better to locate the detector ahead of the suppressor. This location also limits suppressor exposure to backpressure.
- When changing from a buffer to a different operating mobile phase, be sure the solvents are miscible and will not induce precipitation of the buffers. Flush the cell with deionized water immediately after the analysis. Do not allow buffers to remain in the cell for extended periods.

3.1.3 Solvent Delivery System

The pumping system should deliver continuous flow while maintaining a consistent mobile phase composition (if gradient elution is used). For trace-level detection, flow rate irregularities should not cause backpressure variations greater than 10% of baseline pressure. Most pumps are capable of achieving this level of performance, or can be made to do so by the addition of a pulse damper.

The plastics or rubber that are present in some solvent delivery systems are not fully compatible with operation of the AD20 at UV wavelengths, or with the solvents commonly used in reversed phase chromatography. For UV operation, these guidelines are recommended:

- The mobile phase reservoir should be glass, as the plasticizers used in blow-molded components will leach and are strong UV absorbers.
- All tubing connections should be Teflon®, Tefzel®, PEEK, PFA, stainless steel, or titanium as required for the operating pressures and application.

3 • Operation and Maintenance

- Pump seals incorporate a band spring to energize the seal during the vacuum stroke of the piston. The energizer should be stainless steel, a fluoropolymer (Kalrez or fluorosilicone), or other material of known quality. Solvent contact with EPR or Buna rubbers is incompatible with UV operation.

Cleanliness is also important. After operating in detection modes that do not require optically clean reagents (e.g., conductivity), the solvent delivery system may need to be thoroughly cleaned. Some basic cleaning steps are listed below; for additional information, refer to the pump manual.

- Passivate stainless steel systems before the initial analysis, if the system has lost passivation, or after a major disassembly. For instructions, see *Passivation of Stainless Steel Systems and Components* (Document No. 031152).
- Remove non-polar oils and dirt with a dilute soap or surfactant such as sodium dodecylsulfate (SDS), Alconox, or SNOOP. Hot deionized water can also be helpful. To completely remove surfactants, flush the system with dilute methanol or acetone.
- Depending on the polarity of the contaminant, flush the system with acetonitrile or 10% tetrahydrofuran.
- If the system has been contaminated by a precipitate, you may need to flush the system with a strong acid or base.

3.2 Initial Screens

Power-Up Tests

Each time the AD20 power is turned on, the detector runs a series of internal diagnostic and wavelength calibration procedures. During the self-diagnostics, the power supplies, CPU, lamps, filter wheel position, DX LAN communications, SP1 signal processing status, and grating initialization are checked and the visible and UV wavelength are recalibrated.

AD20 Absorbance Detector

As each phase is executed, the test name and result appear on the screen.

Power-Up Screen

If the detector passes all the diagnostic tests, the **POWER-UP** screen is displayed momentarily (Figure 3-1).

The revision codes on the **POWER-UP** screen identify the Moduleware and BIOS, in the event that service is ever needed. If the AD20 is connected to a Dionex PeakNet Workstation via the DX LAN interface, the DX LAN identification number is also displayed here.

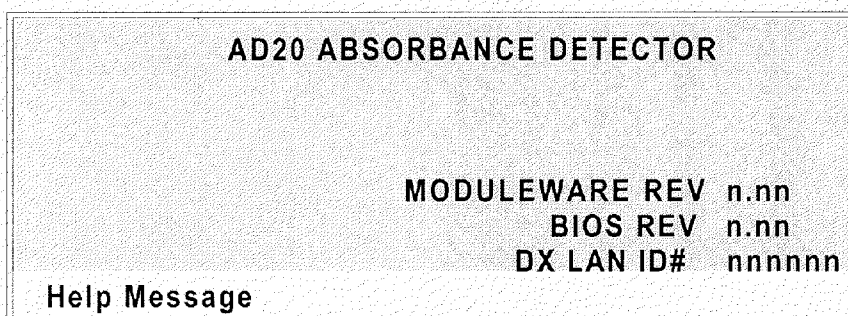

Figure 3-1. Power-Up Screen

Diagnostic Tests Screen

Even if a system component fails a power-up diagnostic test, the tests will continue to run; however, subsequent tests may have to be omitted. If a critical feature fails, the AD20 displays the **DIAGNOSTIC TESTS** screen (one of the options on the **DIAGNOSTIC MENU**). You can run the diagnostics without turning off the detector power and repeating the power-up sequence. See Section C.2.7 for more details about the diagnostic tests.

Main Screen

After 6 seconds, the display changes from the **POWER-UP** screen (or the **DIAGNOSTIC TESTS** screen) to the **MAIN** screen. This screen displays active data in large characters, to enable easy viewing from a distance.

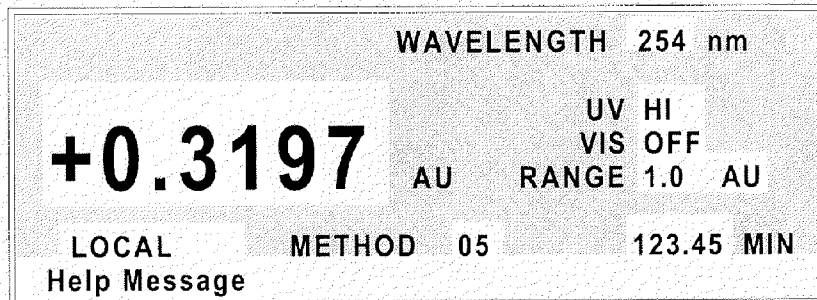

Figure 3-2. Main Screen

Press **Menu** to go to the **MENU of SCREENS**. There, you can begin selecting parameters for the Direct control or Method control operating mode.

3.3 Running Under Direct Control

When the Direct control operating mode is selected, real-time commands are carried out instantly and all detector settings are in effect until you change them. Changes to parameters are executed when entered. Because there are no time-based steps, the method clock is not used. The **Hold/Run** and **Reset** buttons are not operable in Direct control.

To select Direct control, first go to either the **MAIN** or **DETAIL** screen.

- If **DIRECT CNTRL** is displayed, the mode is already selected and no further action is necessary.

AD20 Absorbance Detector

- If **METHOD** is displayed, move the cursor to **METHOD** and press the **Select Δ** or **Select ∇** button to toggle between **METHOD** and **DIRECT CNTRL** in the display. Press **Enter** to activate the selection.

3.4 Running Under Method Control

When the Method control operating mode is selected, a series of programmed timed events, known as a *method*, controls the AD20. Methods are retained in memory even when the detector power is turned off.

There are two ways to select Method control:

- Go to the **MAIN** or **DETAIL** screen. If **METHOD** is displayed, the mode is already selected and no further action is necessary. If **DIRECT CNTRL** is displayed, move the cursor to **DIRECT CNTRL** and press the **Select Δ** or **Select ∇** button to toggle between **DIRECT CNTRL** and **METHOD** in the display. Type in a method number and press **Enter** to activate the selection.
- Go to the **METHOD** screen. Move the cursor to the **RUN** field, enter a method number, and press **Enter**.

If the clock on the **MAIN** or **DETAIL** screen is **INIT** when you press **Enter**, the AD20 uses the method **INITIAL** condition parameters to control the module. If the method clock is greater than zero when you press **Enter**, the AD20 uses the method parameters in effect at that time.

Pressing **Run** starts the method clock. From the **INITIAL** conditions, the time 0.00 step is executed as soon as **Run** is pressed. The remaining steps are executed according to their programmed times.

3.4.1 Creating a New Method

Methods are created from the **METHOD** screen. A method can be created at any time, even while it (or another method) is running. Follow the steps below to create a new method. If necessary, refer to Section 2.1.1 for a review of the function of the front panel buttons.

METHOD		EDIT 33	SAVE TO 33	RUN 25		TTL	RLY
TIME	nm	RANGE AU	OFFSET	MRK		1 2	1 2
INIT	250	1.0				0 0	0 0
0.00			*	*			
0.02						1 1	
4.00 v							
Help Message							

Figure 3-3. Method Screen

1. Go to the **METHOD** screen. Enter an unused method number from 0 through 99 in the **EDIT** field and press **Enter**. This displays a blank method on the screen.

The first step of every method is an initial conditions step with **INIT** in the **TIME** field. The second step is always time step with 0.00 in the **TIME** field. You cannot delete these steps, although you may change their parameters.

2. Enter the parameters for the initial conditions and time 0.00 steps.

NOTE

The **TIME** field is the only field in each method step that *must* have an entered value. Leaving any other field blank indicates that there is “no change” from the value selected for that parameter in the preceding step.

AD20 Absorbance Detector

3. To create a new method step, move the cursor to a blank **TIME** field, enter the time (in minutes) at which you wish an action to be performed, and press **Enter**. Enter the values for each step parameter, or leave a field blank to have the previously selected value remain in effect.
4. Repeat Step 3 to add additional steps. Up to 30 steps (32 steps, if PeakNet Software is used) can be added after the time 0.00 step. If the method contains more steps than can be displayed on the screen at one time, you can view the additional steps by moving the cursor to the top or bottom screen entry and then stepping one more line, as described here:
 - When there is a small v next to the time entry at the bottom of the screen, move the cursor *down* to view the additional steps.
 - When there is a caret (^) next to the top time entry, move the cursor *up* to view the additional steps.
5. To save the new method, move the cursor to the **SAVE TO** field, enter the number that appears in the **EDIT** field, and press **Enter**.

3.4.2 Editing an Existing Method

You can modify an existing method by changing, adding, or deleting steps and/or parameters. If you edit a method while it is running, the changes are stored in memory when you **SAVE TO** the method number. Changes take effect as soon as they are saved.

To edit an existing method, go to the **METHOD** screen, enter the method number in the **EDIT** field, and press **Enter**. Edit the method as described in one of the following sections. Always save your changes before exiting the **METHOD** screen; if you do not, the changes will be lost.

3 • Operation and Maintenance

NOTE

Once you save editing changes to a method, there is no way to recall the original method. If you want to make changes to a method while retaining the original method in its unmodified form, save the new method, or a copy of the original method, under a different method number.

Changing Method Parameters

Move the cursor to the field(s) you want to edit and enter a new value, using the front panel buttons. Press **Enter** after each editing change.

Adding a Method Step

There are two ways to add a step to an existing method:

- Move the cursor on the **METHOD** screen to any **TIME** field. Enter the time and parameters for the new step, and then press **Enter**. If the new step is not at the correct chronological point in the method, it will be moved to the correct location.
- Move the cursor on the **METHOD** screen to the line immediately preceding the intended location of the new step. Press **Insert** to insert a new, blank line below the cursor location. Enter the time and parameters for the new step, and then press **Enter**.

Deleting a Method Step

Move the cursor on the **METHOD** screen to the time of the step to be deleted and press **Delete** twice.

Deleting an Entire Method

Move the cursor on the **METHOD** screen to the **EDIT** field and press **Delete** twice.

AD20 Absorbance Detector

Saving a Modified Method

To *replace* the original method with the modified version, enter the number of the original method in the **SAVE TO** field and press **Enter**.

To *retain* the original method and save the modified version elsewhere in memory, enter an unused method number in the **SAVE TO** field and press **Enter**.

3.4.3 Running a Method

1. Go to the **MAIN** or **DETAIL** screen. If necessary, toggle from **DIRECT CNTRL** to **METHOD** and from **REMOTE** to **LOCAL**.
2. In the **METHOD** field, enter the desired method number and press **Enter**. (You can also select the method number from the **METHOD** screen. To do so, move the cursor to the **RUN** field, enter a method number, and press **Enter**.)
3. If the method clock is already running when you enter the method number, the method will start immediately. If the clock is in Hold, press **Hold/Run** to start the method.
4. The elapsed time on the method clock when the method begins determines where (i.e., at what step and parameters) the method begins running:
 - If the method clock is at **INIT** or time zero, the method begins running using the **INIT** condition parameters.
 - If the method clock is greater than zero, the method begins running using the parameters specified in the step for that elapsed time. Press **Reset** to start the method at the **INIT** conditions.

3.4.4 Changing the Running Method

To change from the method currently running and begin running a different method, enter the new method number in the **RUN** field on the **METHOD** screen and press **Enter**.

The new method begins running using the parameters specified in the step for the current elapsed time. Press **Reset** to start the method at the **INIT** conditions.

3.5 Controlling Another Instrument

The AD20 can control another instrument through the TTL and Relay ports. The TTLs and Relays are programmable within methods, or may be controlled immediately through Direct control. Similarly, another instrument, such as the GP40 Gradient Pump, can control the AD20 by a method in the pump through the TTL input ports in the AD20.

The chromatography system is typically set up so that one module (the pump or autosampler, for instance) contains the Method control and drives other modules (such as the detectors).

3.6 DX LAN Remote Operation

When a PeakNet Workstation is connected to the AD20 via the optional DX LAN interface, you can monitor the detector status remotely and control all detector functions from the computer. For more information, refer to the *PeakNet Software User's Guide*.

3.7 Routine Maintenance

- Periodically check liquid line connections to the cell for leaks and wipe up any spills.
- The PEEK tubing and fitting components may eventually loosen and leak, or pinch off and plug. Periodically check all PEEK tubing for leaks (leaks are sometimes indicated by increasing pressure). Replace tubing and fittings as required (Section 5.1).
- Periodically check the drain tube connected to the leak tray in the optical chassis to make sure the tube is routed below the leak tray and that it is not clogged.
- Replace the lamps when needed. The life expectancy of each lamp depends on the power setting at which it is routinely operated. See Sections 5.5 and 5.6 for replacement instructions for the deuterium and tungsten lamps, respectively.
- The CPU card contains a single-use lithium battery with a life expectancy of 5 years. Dispose of the battery in accordance with local regulations regarding the disposal of lithium. The battery does not contain mercury or heavy metals.
- Repassivate stainless steel systems periodically, especially after a major disassembly or if the system has lost passivation. Operation with extremes of pH will shorten the life of the passivation finish. For instructions, see *Passivation of Stainless Steel Systems and Components* (Document No. 031152).
- Before shutting down the detector for more than 24 hours, flush the system with water to rinse corrosive acids, salts, or bases from the stainless steel flow paths.

4 • Troubleshooting

4.1	No Detector Response	4-3
4.2	Noisy Baseline	4-4
4.3	Drifting Baseline	4-5
4.4	High Background Absorbance	4-6
4.5	Peaks Too Large or Small	4-7
4.6	Lamp Does Not Light	4-7
4.7	Detector Does Not Autozero	4-7
4.8	Cannot Calibrate Wavelength	4-8
4.9	Faulty DX LAN Communication	4-8
4.10	Diagnostics	4-9

AD20 Absorbance Detector

4 • Troubleshooting

This chapter is a guide to troubleshooting routine problems that may occur while operating the AD20 Absorbance Detector. To use this chapter, turn to the section that best describes the operating problem. The possible causes of the problem are listed there in order of probability, along with the recommended courses of action. For additional help, refer to the description of the AD20 diagnostic screens in Appendix C.

If unable to eliminate a problem on your own, notify your Dionex office.

4.1 No Detector Response

- **Analog output range set too high; although the display indicates a response, no recorder response is observed**
Select a more sensitive analog output range.
- **No full-scale output selected**
Select 0.01, 0.10, or 1 volt full-scale.
- **Pump is not pumping**
Check the pressure reading on the pump to make sure the pump is on.
- **Detector offset out of range**
Press **Offset** on the front panel.
- **Lamp not turned on**
Turn on the lamp.

4.2 Noisy Baseline

- **Insufficient time for system equilibration** after turning on the lamp(s), or after a change in mobile phase strength or composition

For most applications, allow at least 15 to 20 minutes for the lamp(s) to warm up. At high sensitivities, a longer warm-up period may be required. After changing mobile phases, allow 20 to 30 column volumes.

Check to see whether the noise is synchronized with the pump stroke; if it is, the piston seal or check valves may need cleaning. Refer to the pump manual for instructions.

- **Leaking fittings**

Locate the source of the leak. Tighten or, if necessary, replace all liquid line connections. If the connections are made with Dionex ferrule fittings, refer to *Installation of Dionex Ferrule Fittings* for tightening requirements.

- **Mobile phase or post-column reagent contains light-absorbing impurities**

Prepare all mobile phases and reagents with spectro-grade solvents, reagent-grade chemicals, and ASTM Type I (or better) filtered, deionized water.

- **Lamp is dimming**

The light output of the lamp decreases over time. Although the lamp may still be functional, the lower light output may increase noise above an acceptable level, especially once the lamp has been in service for more than 1000 hours. If this occurs, replace the lamp. Sections 5.5 and 5.6 contain instructions on replacing the deuterium lamp and tungsten lamp, respectively.

- **Vibration**

Make sure both AD20 front doors are closed during operation.

Make sure no liquid lines are in contact with the photodiode cable.

- **Air bubbles in the flow cell**

Remove the trapped air (Section 5.3).

Degas all solvents before use.

Install a backpressure regulator after the flow cell.

- **Contaminants in the flow cell**

Clean the cell (Section 5.2).

- **Strongly-retained components from a previous analysis are slowly eluting from the column**

To elute strongly-retained species, use a stronger mobile phase. Reequilibrate with the standard mobile phases before resuming normal operation.

Clean the columns as instructed in the column manual. If the problem persists, refer to the troubleshooting section of the column manual for guidance.

4.3 Drifting Baseline

- **Leaking flow cell**

Replace the flow cell.

4.4 High Background Absorbance

- **Mobile phase absorbs strongly at the wavelength in use**
Change the position of the cell in the flow system.
Select an alternate detection wavelength.
Change the mobile phase composition.
- **Impurities in the mobile phase or post-column reagent**
Prepare all mobile phases and reagents with spectro-grade solvents, reagent-grade chemicals, and ASTM Type I (or better) filtered, deionized water.
- **Incorrect post-column reagent flow rate and/or concentration**
Verify that the reagent flow rate is correct. If necessary, remake the reagent and verify the concentration.
- **Air bubbles trapped in the cell**
Remove the trapped air (Section 5.3).
Check that all fittings are tight.
Degas all solvents before use.
Install a backpressure regulator after the flow cell.
- **Film deposited on the cell windows**
Clean the cell (Section 5.2).

4.5 Peaks Too Large or Small

- **Several diverse minor problems**

Check the recorder and integrator input voltage. Verify that the selected full-scale deflection is correct for your recorder. Select the full-scale voltage from the **ANALOG OUT SETUP** screen.

Select a less-sensitive output range.

Change the sample volume or concentration.

Check that the post-column reagent, if used, has not degraded. Verify that the reagent flow rate is correct.

4.6 Lamp Does Not Light

- **Lamp is aged or burned out**

Replace the lamp. See Section 5.5 or 5.6 for instructions on replacing the deuterium lamp and tungsten lamp, respectively.

4.7 Detector Does Not Autozero

- **The lamp has aged, or one or both lamps has burned out**

Replace the lamp. See Section 5.5 or 5.6 for instructions on replacing the deuterium lamp and tungsten lamp, respectively.

- **Condensation on the cell**

Clean the cell window or lenses using filtered, dry air.

- **Loose electrical connection**

Make sure the photodiode cables are latched to the pre-amp, and then check that the pre-amp ribbon cable is fully seated in its connector on the SP1 card. Rezero the detector.

4.8 Cannot Calibrate Wavelength

- **Improperly connected cable(s)**

Open the door to the electrical chassis and make sure the following are connected and fully seated: the lamp cable(s), pre-amp cable, index cable, and grating drive cable. Refer to Figure 2-3, or to the label inside the upper front door, for the component locations.

- **Calibration is not enabled**

Enable lamp calibration (Section C.2.7).

4.9 Faulty DX LAN Communication

- **DX LAN interface incorrectly installed**

Make sure a BNC tee connector (P/N 921914) is connected to the DX LAN connector on the AD20 rear panel. Connect the DX LAN cable (P/N 960404) to one side of the BNC tee connector. The DX LAN cable must be RG58U or RG58AU. Do not use recorder cables; they have the wrong impedance and will interfere with signals on the DX LAN.

Make sure that the tee connectors at both ends of the network are capped with the terminator plugs (P/N 921034) that are shipped with PeakNet Software. See Section B.3.7 for more information.

4.10 Diagnostics

NOTE

Before running the AD20 diagnostics, use the troubleshooting information in this chapter to isolate non-electronic problems.

The AD20 Moduleware includes several diagnostic tests which check the operation of the electronic components to verify the correct functioning of major subsections. Turning on the AD20 power activates a basic diagnostic testing function. More comprehensive diagnostic tests are also available.

For instance, in one of these tests, 90% of the circuitry on the SPI card may be exercised and checked for proper operation. If an error is detected, messages identifying the circuit section and type of malfunction appear on-screen.

To access the diagnostic screens, select the **DIAGNOSTIC MENU** screen from the **MENU of SCREENS**. All of the diagnostic screens are described in Appendix C.

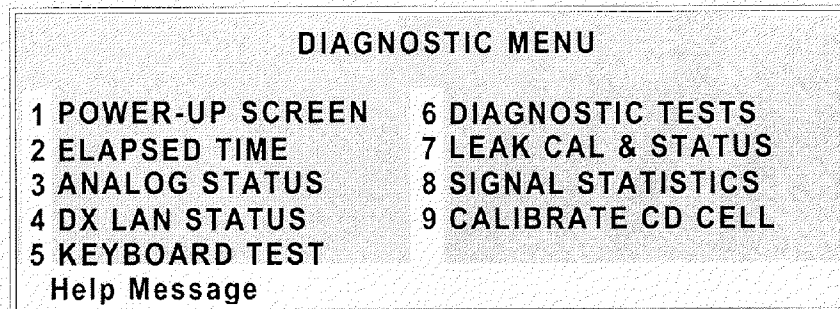

Figure 4-1. Diagnostic Menu

AD20 Absorbance Detector

5 • Service

5.1	Liquid Leaks	5-3
5.2	Cleaning the Cell	5-3
5.3	Removing Trapped Air from the Cell	5-4
5.4	Replacing the Main Power Fuses	5-4
5.5	Replacing the Deuterium Lamp	5-6
5.6	Replacing the Tungsten Lamp	5-7

AD20 Absorbance Detector

5 • Service

This chapter describes routine service procedures for the AD20 Absorbance Detector. Before replacing any parts, refer to the troubleshooting information in Chapter 4 to isolate the cause of the problem. When ordering replacement parts, please include the model number and serial number of the detector.

Substituting non-Dionex parts may impair detector performance, thereby voiding the product warranty. Refer to the warranty statement in the Dionex Terms and Conditions for more information.

NOTE

The AD20 electronic components are not customer-serviceable. Any repairs involving the electronics must be performed by Dionex.

5.1 Liquid Leaks

The PEEK version of the AD20 is plumbed with 1.60-mm (1/16-in) PEEK tubing and Dionex ferrule fittings (P/N 043276) and 10-32 fitting bolts (P/N 043275). For tightening requirements, refer to *Installation of Dionex Ferrule Fittings*.

5.2 Cleaning the Cell

Film deposits on the cell windows cause excessive baseline noise or high absorbance offset.

1. Disconnect the liquid lines from the cell in and out connections.
2. Connect a luer adapter to the cell in connection.
3. Using a syringe, flush the cell with a succession of deionized water, acetone, and 3 M HNO₃. Finally, flush it again with deionized water.
4. Reconnect the cell inlet and outlet lines.

5.3 Removing Trapped Air from the Cell

Air trapped in the cell may cause regular pulsations of the baseline. In addition, trapped air bubbles may cause random noise and low readings. The trapped air may result from air that was introduced in the columns during installation, or from eluent outgassing.

To remove persistent bubbles and avoid outgassing, install an inert backpressure regulator (PEEK regulator, P/N 046480; stainless steel regulator, P/N 039760). The cell backpressure should not exceed 1.38 mPa (200 psi).

An alternative is to install a backpressure line. This increases the cell backpressure, thereby shrinking bubbles and allowing them to pass more easily through the cell. Install a length of 0.25-mm (0.010-in) ID tubing (P/N 042690), with fittings on both ends, after the cell outlet. The backpressure line should be 1 meter long at a flow rate of 1.0 mL/min, 2 meters at 0.5 mL/min, etc. Use a union (P/N 042627) to connect the backpressure line to the waste line.



Do not pump eluent through the column at a flow rate much faster than normal; overpressurization will damage the column.

5.4 Replacing the Main Power Fuses

1. Turn off the AD20 main power switch. Disconnect the main power cord from the AD20 rear panel.
2. The fuse holder is part of the main power receptacle on the rear panel (see Figure 5-1). A recessed lock is located on each side of the fuse holder. Use a small screwdriver, or your fingernails, to push each lock toward the center to release it. The fuse holder will pop out about 0.16 cm (1/16 in) when the locks release. Repeat the process for the other fuse lock. When both locks are released, pull the fuse holder straight out of its compartment.

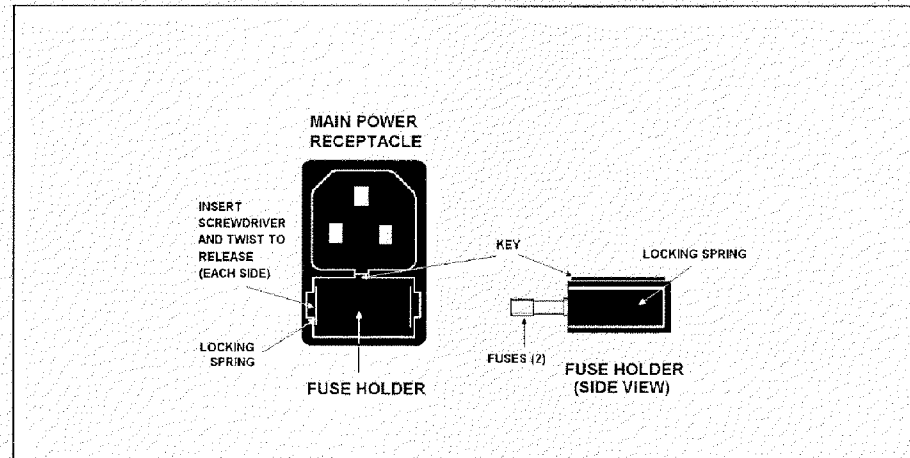

Figure 5-1. Main Power Receptacle

3. The holder contains two fuses. Replace these with new 3.15 amp fast-blow IEC127 fuses (P/N 954745). Dionex recommends replacing both fuses, even though only one may be open. The other fuse has been stressed and could fail even under normal operation.
4. Reinsert the fuse holder into its compartment. The fuse holder is keyed to fit only in its proper orientation. Apply enough pressure evenly against the holder to engage the two locks. When both the locks are engaged, the holder is flush against the panel.
5. Reconnect the main power cord and turn on the power.

AD20 Absorbance Detector

5.5 Replacing the Deuterium Lamp

1. Turn off the deuterium lamp from the AD20 front panel or from the PeakNet Run program. You may leave the detector main power on.



The lamp housing may be hot to the touch, especially when the lamp has been operating at the high power setting. Allow 5 minutes for the lamp housing to cool before continuing.

2. Open the door to the AD20 electronics chassis. Disconnect the 6-pin UV lamp connector from the PIO card (Figure 2-3).
3. Open the door to the AD20 optical chassis. Loosen the drawer lock (see Figure B-2) and pull open the drawer to the first stop. **DO NOT PULL THE DRAWER OUT FURTHER THAN HALFWAY.**
4. Loosen the thumbscrew in the deuterium lamp clamp and pull the clamp away from the lamp mounting tube.
5. Hold the lamp by the top, rock it gently back and forth to loosen it from its socket, and pull the lamp straight up and away from the optical bench. As you do so, note the yellow arrow on the lamp. When the lamp is correctly installed, this arrow is aligned with a locating pin in the lamp socket.
6. While holding the clamp open, align the yellow arrow on the new deuterium lamp (P/N 045230) with the locating pin in the lamp socket and then gently push the lamp into the socket.
7. When the lamp is fully seated, fingertighten the thumbscrew in the lamp clamp.
8. Reconnect the UV lamp connector to the PIO card. Push the optical chassis drawer back into the detector. Make sure the lamp cable is routed through the slot provided for cables and that it is not pinched by the drawer.
9. Close both of the doors on the front of the AD20.

NOTE

If you turned off the AD20 main power before replacing the lamp, skip Steps 10 and 11. The lamp will be recalibrated when you turn on the detector power again.

10. Select Local control. Set the deuterium lamp to High. After turning on the lamp, wait 1 minute for it to warm up.
11. Go to the **DIAGNOSTIC TESTS** screen and select UV CAL to initiate recalibration of the deuterium lamp. When calibration is complete, the detector is ready for normal operation.

5.6 Replacing the Tungsten Lamp

1. Turn off the tungsten lamp from the AD20 front panel or from the PeakNet Run program. You may leave the detector main power on.



The lamp housing may be hot to the touch, especially when the lamp has been operating at the high power setting. Allow 5 minutes for the lamp housing to cool before continuing.

2. Open the door to the AD20 electronics chassis. Disconnect the Vis lamp connector from the PIO card (Figure 2-3).
3. Open the door to the AD20 optical chassis. Loosen the drawer lock (see Figure B-2) and pull open the drawer to the first stop. **DO NOT PULL THE DRAWER OUT FURTHER THAN HALFWAY.**
4. Loosen the tungsten lamp thumbscrews and pull the mounting assembly away from the rear of the optical bench.

AD20 Absorbance Detector

5. Using a Phillips screwdriver, remove the screw securing the tungsten lamp assembly to the socket and remove the assembly.



The terminals in the lamp socket are spring-loaded to clamp the leads of the lamp to the body of the socket. Be careful not to damage the lamp.

6. While holding the mounting assembly by the lead wires, with one thumb and index finger pressing against the back of the mount (to pull on the socket lead wires), insert the new tungsten lamp assembly (P/N 045230) into the socket.
7. Reinstall the Phillips screw that secures the new lamp to the mount.
8. Attach the mounting bracket to the optical bench and tighten the thumbscrews that secure it into place. Dress the tungsten lamp lead wires to the rear of the drawer, away from the right wall.
9. Reconnect the Vis lamp connector to the PIO card. Push the optical chassis drawer back into the detector. Make sure the lamp cable is routed through the slot provided for cables and that it is not pinched by the drawer.
10. Close both doors on the front of the AD20.

NOTE

If you turned off the AD20 main power before replacing the lamp, skip Steps 11 and 12. The lamp will be recalibrated when you turn on the detector power again.

11. Select Local control. Set the tungsten lamp to High. After turning on the lamp, wait 1 minute for it to warm up.
12. Go to the **DIAGNOSTIC TESTS** screen and select VIS CAL to initiate recalibration of the tungsten lamp.
13. Reset the elapsed time for the lamp to zero on the **ELAPSED TIME** screen. The detector is now ready for normal operation.

A • Specifications

A.1	Electrical	A-3
A.2	Environmental	A-3
A.3	Physical	A-3
A.4	Display and Keypad	A-3
A.5	Detector	A-4
A.6	Flow Cell	A-5
A.7	Heat Exchanger	A-5

AD20 Absorbance Detector

A • Specifications

A.1 Electrical

Main Power	90 to 265 Vac, 47/63 Hz; 150 W Max, 100 W typical. The power supply is auto-sensing and requires no voltage adjustment.
Fuse	Two 3.15 amp fast-blow IEC127 fuses (P/N 954745)
Analog Output	User-selectable full-scale output of 10, 100, or 1000 mV

A.2 Environmental

Operating Temperature	10 °C to 40 °C (50 °F to 104 °F)
Operating Humidity	5 to 95% relative humidity (non-condensing)

A.3 Physical

Dimensions	22.5 cm W x 33.5 cm H x 42.0 cm D (8.8 in W x 13.1 in H x 16.4 in D) 6 cm (2.4 in) clearance required behind the detector
Weight	13.6 kg (30 lbs)

A.4 Display and Keypad

Display	Liquid crystal display with adjustable backlighting
Keypad	26 buttons for entering commands and numerical values for screen parameters

AD20 Absorbance Detector

A.5 Detector

Optical System	Dual-beam, fiber-optic beamsplitter and concave holographic diffraction grating
Light Sources	Deuterium lamp (30 W) for ultraviolet spectrum analysis; tungsten lamp (10 W) for visible spectrum analysis
Wavelength Range	190 to 800 nm variable; continuous in 1 nm steps
Wavelength Accuracy	± 1 nm
Bandwidth	8 nm
Absorbance Range	Discrete settings of 0.001, 0.002, 0.005, 0.01, 0.02, 0.05, 0.1, 0.2, 0.5, 1.0, and 2.0 AU
Autozero Capability	2 AU
Autozero Accuracy	± 100 μ AU
Noise	< 10 μ AU peak-to-peak at 254 nm, 2-second rise time, flowing deionized water
Drift	< 100 μ AU/hour (after warm-up) < 100 μ AU/ $^{\circ}$ C (after warm-up)
Filter Rise Time	Discrete settings of 0.05, 0.1, 0.2, 0.5, 1.0, 2.0, 5.0, or 10.0 seconds
Analog Output Range	Discrete settings of 0.001, 0.002, 0.005, 0.01, 0.02, 0.05, 0.1, 0.2, 0.5, 1.0, and 2.0 AUFS
Local Operation	Front panel controls and display status of all functions
Remote Operation	Four of the seven AD20 functions can be controlled via TTL or Relay contacts

DX LAN Operation (Optional) All functions controlled by PeakNet Software on a PC, when connected to the AD20 via the Dionex DX LAN interface

A.6 Flow Cell

Cell Body PEEK

Volume and Optical Path Length Standard bore cell, used with 4 mm (0.016 in) columns: 9 μ L volume, 10 mm (0.002 in) optical path length
Narrow bore cell, used with 4 mm (0.016 in) and 2 mm (0.008 in) columns: 7.5 μ L volume, 6 mm (0.002 in) optical path length
Microbore cell, used with 2 mm (0.008 in) columns: 2.5 μ L volume, 3 mm (0.01 in) optical path length

Maximum Operating Pressure 1.38 mPa (200 psi) with a heat exchanger; 3.45 mPa (500 psi) without a heat exchanger

Chemical Compatibility The use of a base stronger than 0.1 M is not recommended, as it will etch the silica windows.

A.7 Heat Exchanger

Coil for 2 mm Columns Volume of 20 μ L; dispersion of 2.2 μ L at 1.0 mL/min

Coil for 4 mm Columns Volume of 60 μ L; dispersion of 5.3 μ L at 1.0 mL/min

AD20 Absorbance Detector

B • Installation

B.1	Facilities Required	B-3
B.2	System Configuration	B-4
B.3	Unpacking	B-5
B.4	Installation	B-6
B.4.1	Power	B-6
B.4.2	Flow Cell	B-7
B.4.3	Heat Exchanger	B-9
B.4.4	Waste Line	B-9
B.4.5	Detector Output	B-9
B.4.6	Relay/TTL Control	B-10
B.4.7	DX LAN Network (Optional)	B-12

AD20 Absorbance Detector

B • Installation

B.1 Facilities Required

- Make sure the AD20 installation site meets the electrical and environmental specifications listed in Appendix A.
- Install the AD20 on a sturdy table or workbench, at a height that ensures convenient viewing of the front panel display.
- Allow at least 6 cm (2.4 in) clearance behind the detector for power connections and ventilation. Room air is inducted into the detector to cool the electronics and dissipate the heat generated by the lamps. Do not obstruct air flow to the rear of the detector.

AD20 Absorbance Detector

B.2 System Configuration

Dionex DX 500 modules are designed to be stacked on top of each other, up to a maximum height of four units (see Figure B-1). The AD20, for example, is two units high. Stacking the interlocking modules creates a compact system that requires a minimal amount of bench space; it also allows the length of tubing and cable connections to be minimized. All cables are routed through the front slots and rear chases under the modules.

NOTE

The Ship Kits for the DX 500 pumps and chromatography modules contain a shoe (P/N 046478) and two ties (P/N 046476). These items help secure the AD20 to other DX 500 modules, preventing the modules from tilting or sliding apart. Installation of the shoe and ties is optional; for installation instructions, refer to the pump or chromatography module manual.

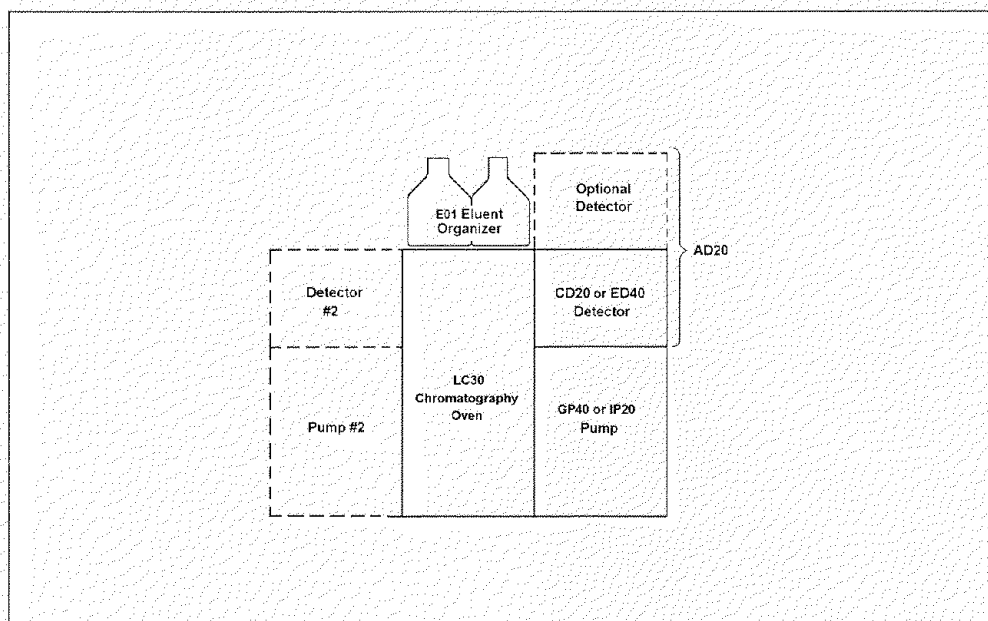

Figure B-1. Recommended DX 500 System Configuration

B.3 Unpacking



When moving or carrying the AD20, lift only from the bottom or side of the detector. Lifting with the front panel door will damage the door hinges.

1. Carefully remove the AD20 from its shipping container, using the lift strap. Be careful not to tip the detector forward.
2. Open the door to the optical chassis (the lower unit of the AD20 enclosure). Loosen the drawer lock (see Figure B-2) and pull open the drawer to the first stop.
3. Two bolts clamp the optical bench to the optical chassis drawer (see Figure B-2) to prevent shipping damage. Loosen the screw on each shipping bolt three turns. Note: If it is ever necessary to reship the detector, remember to first retighten these screws.

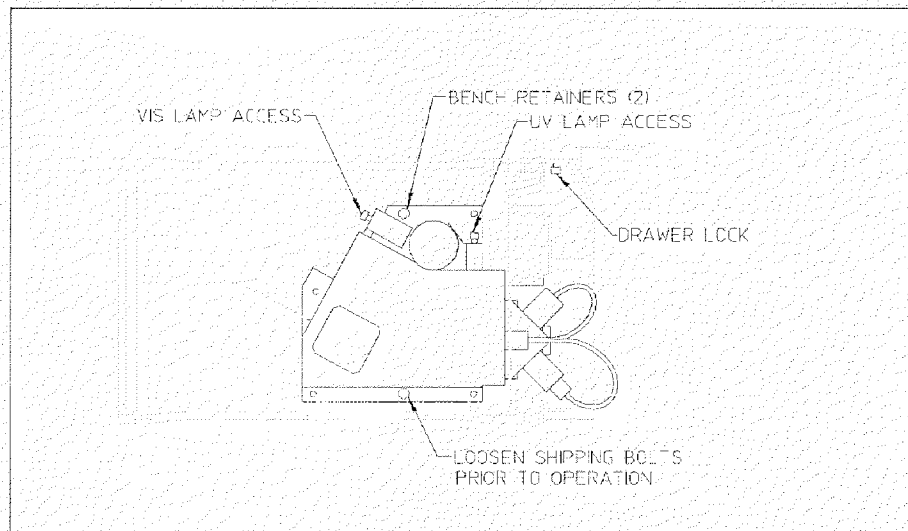

Figure B-2. Optical Bench Shipping Bolts

AD20 Absorbance Detector

4. Remove the block of packing material in the optical drawer. Save the shipping container and all packing material in the event that the detector needs to be shipped again.
5. Do not turn on the detector unless it is at room temperature (10 to 40 °C or 50 to 104 °F). If the detector is moved from a cold environment (outside in winter) to a warm environment (heated room) allow at least 1 hour for condensation to evaporate before turning on the power.

B.4 Installation

B.4.1 Power

You can control power to the AD20 from the main power switch on either the ED40 or, if present, the LC30 Chromatography Oven. In either case, no adjustment is required to select the line voltage.

For on/off control from the AD20, connect the modular power cord (IEC 320 C13) provided with the AD20 from the main power receptacle on the AD20 rear panel (Figure B-3) to a grounded, single-phase power source.

The LC30, when properly connected to other modules in the chromatographic system, can function as the main power source for the system. The LC30 Ship Kit provides IEC jumper power cables (P/N 960748) for this purpose. Connect a jumper cable from the AD20 main power receptacle to one of the four IEC auxiliary receptacles on the LC30 rear panel. Leave the AD20 power switch on continuously and use the LC30 main power switch to turn the detector on and off.



SHOCK HAZARD—To avoid electrical shock, a grounded receptacle must be used. Do not operate or connect to AC power mains without an earthed ground connection.

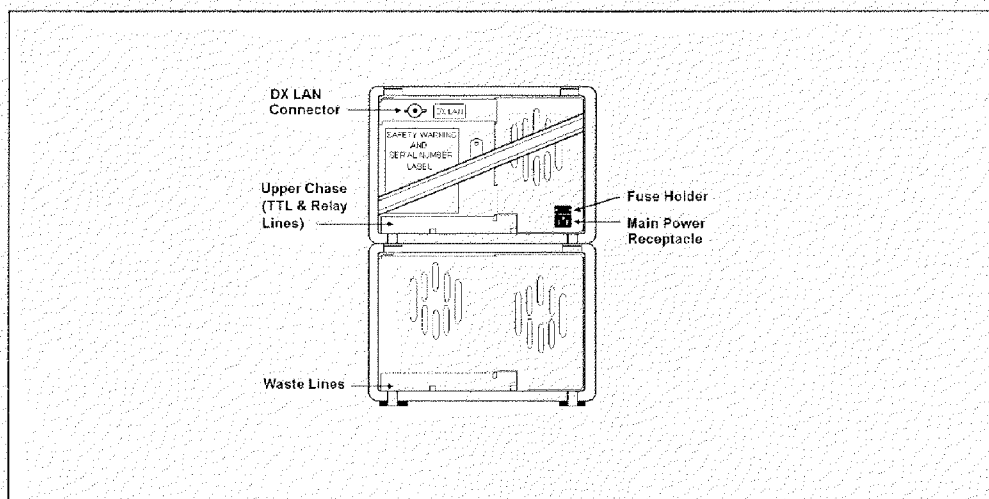

Figure B-3. AD20 Rear Panel



Operation at AC input levels outside of the operating voltage specified range may damage the detector.

B.4.2 Flow Cell

1. Thread the cell onto the photodiode. Be careful not to touch the cell window. If you accidentally touch the window, clean it with denatured alcohol and a clean tissue.
2. The tubing used for cell connections depends on the length of the optical path:
 - For standard bore (10 mm) and narrow bore (6 mm) cells, 0.25-mm (0.010-in) ID tubing is recommended.
 - For microbore (3 mm) cells, 0.125-mm (0.005-in) ID tubing may be used.

AD20 Absorbance Detector

3. Attach the outlet line to the top of the cell and the inlet line to the bottom of the cell. For easiest access, the outlet tube fitting should angle toward the beamsplitter mount, and the inlet fitting should angle toward the photodiode. Connecting the inlet tubing to the bottom will help prevent air bubbles from being trapped in the cell.
4. You are now ready to mount the cell on the angled face of the beamsplitter. This orientation minimizes dead volume. For trace-level analyses, mount the cell on the left side of the beamsplitter. For other applications, you may mount the cell on either the right or left side.

After docking the cell to the optical port, align the cell square with the beamsplitter, with the cell latches clear of the latch pins, and twist the cell slightly while pushing it onto the face of the beamsplitter. (The optical bench may move slightly, as it is shock-mounted.)

5. If the cell outlet connection provides some restriction, thereby generating a small amount of backpressure, bubble formation will be minimized. An inert backpressure regulator (PEEK regulator, P/N 046480; stainless steel regulator, P/N 039760) or a backpressure line consisting of 100 cm of 0.25-mm (0.010-in) ID capillary tubing is recommended for this purpose.



Do not use normal phase or chlorinated solvents with PEEK components, as these will damage the flow cell.

B.4.3 Heat Exchanger



Operating at backpressures greater than 1.38 mPa (200 psi) will damage the heat exchanger. For applications that require extremely low dead volume, or have very high backpressure after the detector, you may bypass the heat exchanger.

The heat exchanger assembly is mounted immediately below the flow cell. Connections to the heat exchanger are made at the manifold. Connect the cell inlet to either port of the manifold.

B.4.4 Waste Line

Connect the leak drain tube to the rear of the optical chassis drawer, near the base. Place the free end of the tubing in an approved waste container below the bench level.

B.4.5 Detector Output

The recorder connections are accessible in the electronics chassis.

Connect a recorder or an integrator to the 3-pin connector on the SP1 analog output, using the twisted wire (P/N 043598) and connector (P/N 921186) provided in the AD20 Ship Kit. The connector pinout is as follows:

- Pin 1 Signal +
- Pin 2 Signal -
- Pin 3 Chassis ground
(some installations may require a grounded shield)

AD20 Absorbance Detector

B.4.6 Relay/TTL Control



SHOCK AND FIRE HAZARD—Inputs and outputs are not rated for connection to AC mains power. **DO NOT CONNECT TO 100, 115, 220, 230 OR 240 VAC POWER SOURCES. FIRE OR ELECTROCUTION MAY RESULT.**

The AD20 Ship Kit includes eight 2-pin connectors—4 input and 4 output. You can attach individual wires and twisted pairs to these plugs. Strip the end of the wire(s), insert into the plug, and use a screwdriver to tighten the plug locking screw. For connector locations, refer to the label on the inside of the door to the electronics chassis.

Connections 1 and 2 can be programmed to switch any low-voltage control. The switched current must be less than 200 mA and 42 V peak.

The table below describes the pinouts for the Relay/TTL connectors.

Connector Number	Pin Number	Description
Relay 1	1 and 2	Solid State Relay Contacts Out
Relay 2	1 and 2	Solid State Relay Contacts Out
Relay 3	1	TTL Out (1 k Ω pull up to +5, 100 mA sink)
	2	Ground
Relay 4	1	TTL Out (1 k Ω pull up to +5, 100 mA sink)
	2	Ground
Relay 5	1	Input TTL 1
	2	Ground
Relay 6	1	Input TTL 2
	2	Ground
Relay 7	1	Input TTL 3
	2	Ground
Relay 8	1	Input TTL 4
	2	Ground

TTL inputs 1, 2, 3, and 4 (relays 5 through 8) in the preceding table can be used to control the following functions:

- OFFSET Recorder
- HOLD/RUN Program
- UV LAMP ON/OFF
- TUNGSTEN LAMP ON/OFF
- METHOD NUMBER INCR
- METHOD NUMBER DECR
- MARK Recorder
- Increase Recorder RANGE \times 10

See Section C.1.7 for setup instructions.



The relay output, TTL output, and TTL inputs use the same style of connector. Connection of relay loads and their power sources to the TTL outputs will damage the TTL output stage. If the relay load can source more than 200 mA at 5V or higher, damage to the CPU module may result.

AD20 Absorbance Detector

B.4.7 DX LAN Network Connection (Optional)

In order for the AD20 to communicate with PeakNet Software, you must install a detector interface card (P/N 044196) in the AD20 and connect the DX LAN cable (P/N 960404) to the DX LAN connector on the AD20 rear panel.



STATIC—The AD20 electronics are not user-serviceable and the detector interface card should be installed by qualified personnel only. Observe standard anti-static procedures when installing the interface card or handling the CPU card.



To prevent damage to the detector, turn off the main power before installing the interface card. After confirming that the LED on the CPU card is off (not green or red), unplug the power cord from the mains. Do not rely on the front panel power switch actuator.

1. Remove the TTL/Relay plugs from the connectors at slot 4, the SP card. Refer to the label on the inside of the front door for the card location.
2. Disconnect the 60-pin ribbon cable from the AD20 front panel. Close the tilt panel to expose the connector and its ejector latches. Remove the cable by opening the ejector latches.
3. Using a screwdriver as a lever, open the white ejector latch at the bottom of the CPU card. Remove the CPU card, cable, and Relay card as a single unit.
4. Insert the detector interface card (P/N 044196) into slot 4. Slide the card to the rear. Verify that the BNC connector is aligned with the hole at the rear and the card is aligned with the connector. Press firmly on the card until it mates fully with the connector on the rear panel.

5. Reinstall the CPU/Relay card. Press firmly until the CPU card is inserted into the connector on the rear panel.
6. Reconnect the ribbon cable to the 60-pin connector on the front panel. The header and connector are key-polarized near the center. The ejector latches should be partially open to accept the cable connector.
7. If the detector is the last module in the network to be connected, install a terminator plug (P/N 921034), shipped with PeakNet Software, on the remaining port of the BNC tee connector. If this is not the last module, connect the cable from the next module to the BNC tee.



IMPORTANT

Terminator resistor plugs must be installed at each end of the DX LAN. Verify that both ends of the DX LAN have resistor plugs installed.

8. Connect the DX LAN cable (P/N 960404) to the DX LAN connector.

NOTE

If necessary, a 15-meter (50-ft) DX LAN extension cable (P/N 046016) is available from Dionex.

AD20 Absorbance Detector

C • User Interface

C.1	Operational Screens	C-3
C.1.1	Menu of Screens	C-4
C.1.2	Main Screen	C-5
C.1.3	Detail Screen	C-7
C.1.4	Method	C-9
C.1.5	Module Setup	C-11
C.1.6	Analog Out Setup	C-12
C.1.7	Time Function In	C-13
C.2	Diagnostic Screens	C-14
C.2.1	Diagnostic Menu	C-14
C.2.2	Power-Up Screen	C-15
C.2.3	Elapsed Time	C-16
C.2.4	Analog Status	C-17
C.2.5	DX LAN Status	C-19
C.2.6	Keyboard Test	C-21
C.2.7	Diagnostic Tests	C-22
C.2.8	Leak Sensor Calibration and Status	C-25
C.2.9	Signal Statistics	C-26
C.2.10	Offset Zero Calibration	C-27

AD20 Absorbance Detector

C • User Interface

This appendix illustrates and describes all of the screens available for display on the front panel of the AD20 Absorbance Detector. There are two categories of screens: operational and diagnostic (see Figure C-1).

- *Operational* screens enable you to create, edit, and run methods that control detector operation, and to select default parameters for the detector.
- *Diagnostic* screens provide access to AD20 diagnostic information and tests.

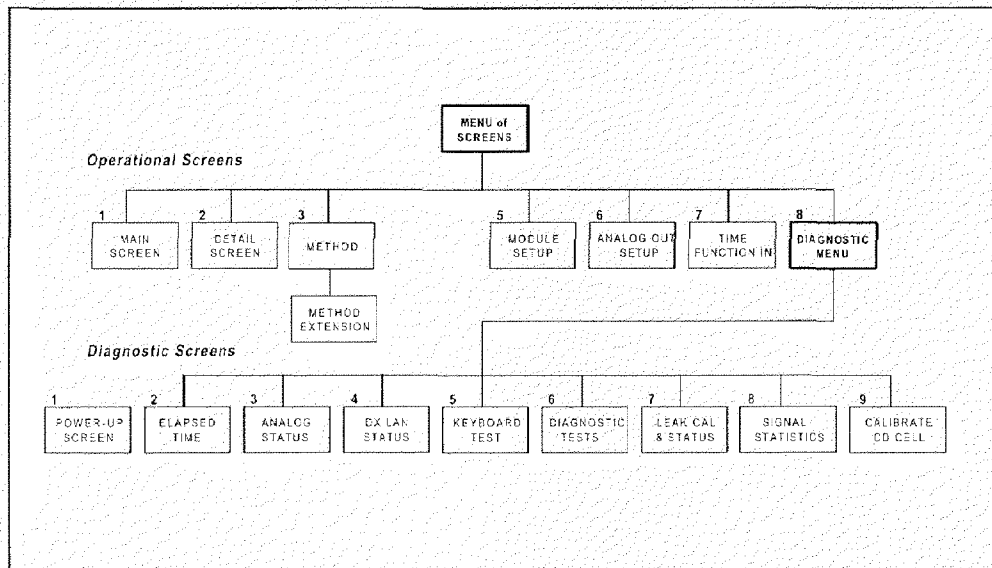

Figure C-1. AD20 Menu Structure

C.1 Operational Screens

C.1.1 Menu of Screens

The **MENU of SCREENS** provides top-level access to the menu structure.

MENU of SCREENS	
1 MAIN SCREEN	5 MODULE SETUP
2 DETAIL SCREEN	6 ANALOG OUT SETUP
3 METHOD	7 TIME FUNCTION IN
4 - - -	8 DIAGNOSTIC MENU
Help Message	

Figure C-2. Menu of Screens

There are two ways to select a screen from this menu:

- Use the cursor directional buttons to move the cursor to the field containing the screen number and press **Enter**.
- Press the number button on the front panel keypad that corresponds to the screen.

To display a brief description of each menu, press the **Help** button.

C.1.2 Main Screen

The **MAIN** screen displays active data in large characters to make viewing easier from a distance.

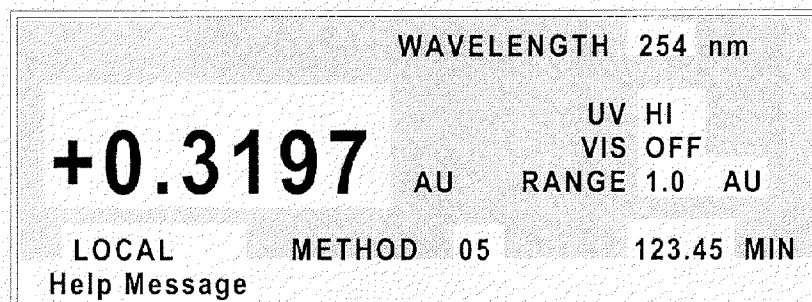

Figure C-3. Main Screen

WAVELENGTH	Displays the selected wavelength (nm) for the absorbance determination. The wavelength is selected using the front panel keypad, by a method, or by remote control via the DX LAN. <ul style="list-style-type: none"> • UV Lamp—190 to 380 nm • VIS Lamp—381 to 800 nm Selecting a wavelength does not control the lamps; you must turn the lamps on and off as required.
AU	Displays the measured absorbance. Absorbance measurements are made relative to an internal offset, which is determined each time the offset auto zero function is activated.
UV (Lamp)	The deuterium lamp has three settings— OFF , LO , and HI . The lamp starts after a 20-second warm-up period, but requires 1 hour to stabilize. Measurements made during the warm-up period will drift. The deuterium lamp may be set by Local or Remote inputs.

AD20 Absorbance Detector

VIS (Lamp)	The tungsten lamp has three settings— OFF , LO , and HI . The tungsten lamp may be set by Local or Remote inputs.
RANGE	There are eleven discrete settings for the analog output (recorder) range—0.001, 0.002, 0.005, 0.01, 0.02, 0.05, 0.1, 0.2, 0.5, 1.0, and 2.0 AUFS. See the description of the ANALOG OUT SETUP screen for additional analog (recorder) settings.
Control Mode	Sets the detector to Local or Remote control.
MIN	Shows the method clock elapsed time, initial conditions, or is blank. This value can be edited. When you enter a new elapsed time, the method settings corresponding to the new time take effect.

C.1.3 Detail Screen

The **DETAIL** screen contains all the fields on the **MAIN** screen, as well as the TTL and Relay fields and fields to control absorbance. Refer to the **MAIN** screen for a description of fields that are common to both screens.

DETAIL SCREEN				
OUTPUT	-0.00001 AU	UV ON	TTL1	0
OFFSET	0.15482 AU	VIS OFF	TTL2	1
TOTAL	0.15481 AU	RANGE 0.001 AU	RLY1	1
			RLY2	0
	WAVELENGTH	254 nm		
LOCAL	METHOD	05	123.45	MIN
Help Message				

Figure C-4. Detail Screen

OUTPUT	The output absorbance measurement is made relative to an internal offset which is determined each time the auto zero function is activated.
OFFSET	The display offset may be set up in one of two modes—background compensated or uncompensated. The uncompensated offset may vary from 0.1 to 0.6. Values greater than this may indicate problems with the eluent or the operating wavelength. Background compensation allows this value to be zeroed. For more information, see the OFFSET ZERO CALIBRATION screen.
TOTAL	The sum of the current absorbance output and the absorbance offset.
TTL1 TTL2	Provides TTL control of accessories. In a method, these values occur according to the method timing. In keypad control, select on (1) or off (0).

AD20 Absorbance Detector

RLY1	Provides relay contact closure control of accessories. In a method, these values occur according to the method timing. In keypad control, select on (1) or off (0).
RLY2	
METHOD	Selects the method number (0 through 99) to run.

C.1.4 Method

A method consists of a series of timed steps. Each step has a set of parameters associated with it.

Initial conditions are applied when a method is invoked. A lower case *v* next to the last step on the display indicates that the method contains more steps.

Blank fields denote no change from the previous step. The **Delete** button blanks the field.

METHOD	EDIT 33	SAVE TO 33	RUN 25	TTL	RLY
TIME	nm	RANGE AU	OFFSET	MRK	1 2 1 2
INIT	250	1.0			0 0 0 0
0.00			*	*	
0.02					1 1
4.00 v					
Help Message					

Figure C-5. Method Screen

EDIT	Specifies the method number (0 through 99) to edit.
SAVE TO	Specifies the method number (0 through 99) the current method should be saved to.
RUN	Specifies the method number (0 through 99) to run. The Hold/Run button controls running the method.
TIME	Specifies the start time for each step. Times are sorted in chronological order. If you edit a method while it is running, the run time will appear above this field.
nm	Sets the wavelength in nanometers.

AD20 Absorbance Detector

RANGE	Sets the range.
OFFSET	Stores the offset value. The baseline is set by subtracting the offset measured when this step executes from all subsequent measurements. An asterisk (*) indicates that this toggle is set.
MARK	Sends a positive pulse to the analog output (recorder) as an event marker. An asterisk (*) indicates this toggle is set.
TTL	Sets TTL1 and TTL2 to on (1) or off (0).
RLY	Sets RLY1 and RLY2 to on (1) or off (0).

C.1.5 Module Setup Screen

The backlight intensity, key beep, and error beep are configured from the **MODULE SETUP** screen.

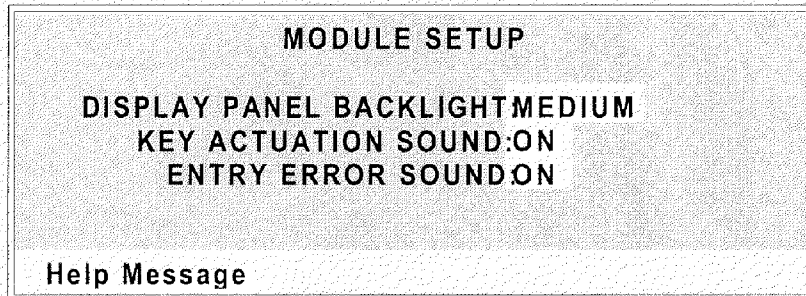

Figure C-6. Module Setup Screen

**DISPLAY PANEL
BACKLIGHT**

Sets the display panel backlight to **LOW**, **MEDIUM**, **HIGH**, or **OFF**. After 2 hours of inactivity from the keypad, the backlight is automatically turned off. Press any button to turn the backlight on.

**KEY ACTUATION
SOUND**

Toggles the keypad touch sound. When this option is selected, the detector sounds a beep (880 Hz) when a button is pressed.

**ENTRY ERROR
SOUND**

Toggles the error sound. When this option is selected, the detector sounds a beep (440 Hz) when an invalid entry is made.

AD20 Absorbance Detector

C.1.6 Analog Output Setup

The **ANALOG OUTPUT SETUP** screen contains parameters for setting the analog output for accessories such as a recorder or integrator.

ANALOG OUTPUT SETUP		
OUTPUT:	OFFSET	
ZERO POSITION:	10	% FULL-SCALE
VOLTS, FULL-SCALE:	1.00	V
RISE TIME:	1.00	sec
POLARITY:	+	

Help Message

Figure C-7. Analog Output Setup Screen

OUTPUT	Sets the analog output to one of the following: OFFSET uses the offset zeroed output level value, ZERO sets the offset recorder output to zero, and FULL SCALE sets the output to the full-scale setting.
ZERO POSITION	Sets the analog (recorder) offset level (0 to 100%).
VOLTS, FULL-SCALE	Sets the full-scale voltage to 1.0, 0.1, or 0.01 volts.
RISE TIME	Sets the rise time to 0.05, 0.1, 0.2, 0.5, 1.0, 2.0, 5.0, or 10.0 seconds. Rise time is a measure of how quickly the detector responds to a change in signal. The filter is a Bessel filter for optimal noise rejection and low signal distortion.
POLARITY	Determines the output voltage polarity. The output is typically set to positive polarity.

C.1.7 Time Function In

Figure C-8 shows the **TIME FUNCTION IN** screen. Four input TTL controls may be assigned to the time input functions.

Use the **Select** buttons to assign TTL1 through TTL4 to any four of the time functions. TTL input ports can also be assigned to the **INCR** and **DECR** fields to increase or decrease the method number.

TIME FUNCTION IN MODE: NORMAL EDGE			
OFFSET:	TTL 1		
HOLD/RUN:	TTL 2		
LAMP OFF/ON:	UV TTL 3	VIS	TTL -
METHOD NUMBER:	INCR TTL 4	DECR	TTL -
MARK:	TTL -		
RANGEx10:	TTL -		
Help Message			

Figure C-8. Time Function In Screen

C.2 Diagnostic Screens

To access the AD20 diagnostics, select the **DIAGNOSTIC MENU** from the **MENU of SCREENS**. While a diagnostic screen is displayed, pressing the **Menu** button returns you to the **DIAGNOSTIC MENU**. From the **DIAGNOSTIC MENU**, pressing **Menu** returns you to the **MENU of SCREENS**.

C.2.1 Diagnostic Menu

Figure C-9 shows the **DIAGNOSTIC MENU**. The nine menu options are explained in detail in the following sections.

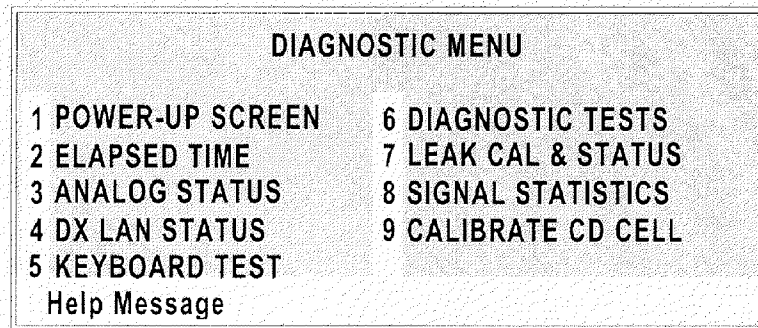

Figure C-9. Diagnostic Menu Screen

C.2.2 Power-Up Screen

This screen displays the revision numbers for the Moduleware and BIOS code. It also displays the identification number of the optional DX LAN interface, if connected.

The AD20 conducts a wavelength calibration test upon power-up. If test results are negative, a warning beep sounds and an error message appears.

- If the error message indicates a deuterium or tungsten lamp failure, test/recalibrate the source from the **DIAGNOSTIC TESTS** screen. If the message reappears, notify Dionex.
- If the error message indicates a UV or visible wavelength calibration failure, turn off the AD20 power for a few seconds and then turn it back on. If the message reappears, test/recalibrate the source from the **DIAGNOSTIC TESTS** screen. If this does not eliminate the problem, notify Dionex.

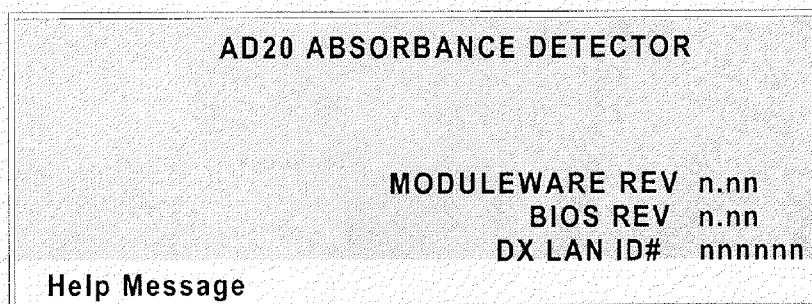

Figure C-10. Power-Up Screen

AD20 Absorbance Detector

C.2.3 Elapsed Time

The **ELAPSED TIME** screen reports for how long (in hours) various AD20 parameters have been in use. The status of each parameter is updated in real time.

ELAPSED TIME		RESET
MODULE ON:	nnnnnn hours	
BACKLIGHT:	nnnnnn hours	
VISIBLE LAMP:	nnnnnn hours	*
UV LAMP:	nnnnnn hours	AUTO

Help Message

Figure C-11. Elapsed Time Screen

MODULE ON	Reports the total time the detector has been powered up in its lifetime.
BACKLIGHT	Reports the total time the LCD backlight has been on in its lifetime.
VISIBLE LAMP	Reports the total time the tungsten lamp has been on. To reset this field to zero after changing the lamp, use one of the Select buttons to display "*" and press Enter .
UV LAMP	Reports the total time the deuterium lamp has been on. This field is automatically reset to zero when the lamp is replaced.

C.2.4 Analog Status

The **ANALOG STATUS** screen displays the status of several analog test points. If a run is in progress, the status updates are from the last idle state; if no run is in progress, the values are in real time.

ANALOG STATUS	
SAMPLE ENERGY:	99.999 nanoAmps
REFERENCE ENERGY:	99.999 nanoAmps
LEAK SENSOR:	9.999 volts
VOLTAGE REF #1:	99.999 volts
VOLTAGE REF #2:	-99.999 volts
VOLTAGE REF #3:	-9.999 volts
Help Message	

Figure C-12. Analog Status Screen

SAMPLE ENERGY	Reports the sample intensity. If it is not greater than 5 nanoAmps, it may be advisable to check the lamps and the operating wavelength.
REFERENCE ENERGY	Reports the reference intensity. If it is not greater than 5 nanoAmps, it may be advisable to check the lamps and the operating wavelength.
LEAK SENSOR	Reports the leak sensor voltage. It should be greater than 1 V, less than 4 V, and nominally 2.5 V.
VOLTAGE REF #1	Reports the voltage at the +10 V reference. If it is not $+10 \pm 0.1$ V, the SP1 card should be replaced.
VOLTAGE REF #2	Reports the voltage at the -10 V reference. If it is not -10 ± 0.2 V, the SP1 card should be replaced.

AD20 Absorbance Detector

VOLTAGE REF #3

Reports the A/D zero offset voltage. If it is not -1.00 ± 0.02 V, the SP1 card should be replaced.

C.2.5 DX LAN Status

The DX LAN driver monitors the network for several types of possible errors. The detector reads the DX LAN error counts and displays them on this screen, along with the DX LAN addresses. The error counts should read zero. Most errors are caused by a defective cable, missing or incorrectly terminated cable. The DX LAN cable must be RG58U or RG58AU.

```

DX LAN STATUS
UNIQUE DX LAN ID:FF FF FF FF
DX LAN ADDRESS:FF FF FF FF FF FF

COLLISION: nnn   ALIGNMENT: nnn   CRC:nnn
BUS WRITE: nnn   BUS READ: nnn   RUNT: nnn
UNDERFLOW: nnn  OVERFLOW: nnn  RETRY: nnn
Help Message

```

Figure C-13. DX LAN Status Screen

UNIQUE DX LAN ID	Displays the three-byte DX LAN ID programmed into the detector Moduleware (in HEX). The ID is unique to the detector and never changes.
DX LAN ADDRESS	Displays the six-byte DX LAN address assigned by the PC (in HEX). The first three bytes are the system assignment and the last three bytes are the assignment within the system.
COLLISION	Indicates that 16 unsuccessful transmissions of the same packet occurred, due to collisions.
BUS WRITE	Indicates that a ready response could not be issued within 2.4 microseconds after the WR signal is asserted. This occurs when the transmit buffer memory is full.

AD20 Absorbance Detector

UNDERFLOW	Indicates that data from the transmit section of the hardware buffer memory is not available for serial transmission. The DX LAN will continue to send out this data frame.
ALIGNMENT	Indicates that a packet was received with an alignment error, meaning that there were one to seven extra bits at the end of the packet. This usually indicates a collision or a faulty transceiver.
BUS READ	Indicates that a ready response could not be issued within 2.4 microseconds after the ready signal is asserted. This occurs when reading an empty buffer.
OVERFLOW	Indicates that the DX LAN hardware receive buffer became full and had to reject a packet for lack of space.
CRC	Indicates that a packet was received with a CRC error. This usually means that a collision has corrupted the packet.
RUNT	Indicates that a "runt" packet (one less than 15 bytes in length) was received. This usually occurs after a collision has truncated the original length.
RETRY	Indicates the number of retries required to transmit the last packet.

C.2.6 Keyboard Test

You can conduct an interactive test of the AD20 front panel buttons from the **KEYBOARD TEST** screen. Pressing any front panel button changes the corresponding button indicator on the screen to reverse video. This confirms proper operation of that button. When you release the button, the screen returns to normal video.

OFFSET	RUN/HOLD	UP	7	8	9	
MARK	RESET	LEFT	RIGHT	4	5	6
INSERT	SEL UP	DOWN	1	2	3	
DELETE	SEL DOWN	HELP	MENU	0	.	E
Help Message						

Figure C-14. Keyboard Test Screen

AD20 Absorbance Detector

C.2.7 Diagnostic Tests

Tests conducted from this screen verify the integrity of the AD20 electronics and functions.

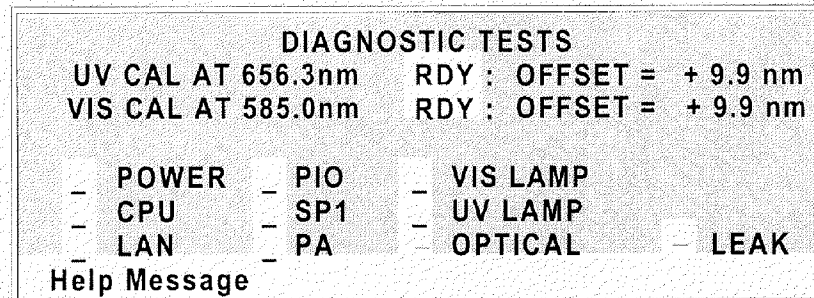

Figure C-15. Diagnostic Tests Screen

UV CAL AT 656.3 nm Selects one of three options to test or calibrate the deuterium lamp at 656.3 nanometers:

RDY—The diagnostic is idle and ready to be run.

RUN—The diagnostic will initiate a calibration test of the deuterium lamp.

CAL—The diagnostic will initiate a calibration of the deuterium lamp. Wavelength calibration takes 1 minute.

At the conclusion of the test or calibration, this field changes back to RDY, the offset from zero that was measured during the calibration or test is now displayed at the end of the line, and the previously selected wavelength is restored.

OFF—Disables the wavelength calibration for the selected source lamp. In the event that one of the lamps is bad, its wavelength calibration failure can be ignored and operation with the other lamp can continue.

- VIS CAL AT 585.0 nm** Selects one of three options to test or calibrate the tungsten lamp at 585.0 nanometers:
- RDY**—The diagnostic is idle and ready to be run.
- RUN**—The diagnostic will initiate a calibration test of the tungsten lamp.
- CAL**—The diagnostic will initiate a calibration of the tungsten lamp. Wavelength calibration takes 1 minute.
- At the conclusion of the test or calibration, this field changes back to **RDY**, the offset from zero that was measured during the calibration or test is now displayed at the end of the line, and the previously selected wavelength is restored.
- OFF**—Disables the wavelength calibration for the selected source lamp. In the event that one of the lamps is bad, its wavelength calibration failure can be ignored and operation with the other lamp can continue.

The following tests can be run from the **DIAGNOSTIC TESTS** screen. Select the asterisk (*) in the field beside the name of the test and press **Enter** to immediately begin running the test. When the test is complete, the entry field displays either **P** (pass) or **F** (fail).

NOTE

These test and calibration procedures disturb detector equilibration as the lamps are cycled on and off, and the optical system is cycled through its test modes. After testing, allow the system to equilibrate before resuming operation.

- **POWER**—Checks the +5, ±15, and +24 volt monitor on the Relay card.
- **CPU**—Checks the internal CPU configuration and Moduleware checksum.

AD20 Absorbance Detector

- LAN—Checks the configuration and loop-back of the DX LAN hardware.
- PIO—Checks the internal monitor against the lamp control status.
- SPI—Checks the initialization of control registers, tests the A/D voltage references, and checks the D/A unit.
- PA—Checks the gain control to the Pre-Amp. This test requires that the detector have first passed the SPI test (above).
- VIS LAMP—Turns on the tungsten lamp and checks an internal PIO monitor. With the optical drawer open, the lamp may be observed.
- UV LAMP—Turns on the deuterium lamp and checks an internal PIO monitor.
- OPTICAL—Checks the filter wheel position and the visible zero order (if PA passed).
- LEAK—Checks the correct, open circuit, or short circuit condition of the leak sensor.

C.2.8 Leak Sensor Calibration and Status

This screen reports the status of leak sensor parameters.

LEAK SENSOR CALIBRATION AND STATUS	
MEASURED VALUE:	2.48
CURRENT CONDITION:	RDY
CALIBRATION VALUE:	2.50
LOWER THRESHOLD:	2.40

Help Message

Figure C-16. Leak Sensor Calibration and Status Screen

MEASURED VALUE	Reports the measured voltage from the leak sensor.
CURRENT CONDITION	Reports the current (error) conduction of the leak sensor: WET, DRY, or ERR. Error indicates an open or short circuit. To calibrate a leak sensor, select CAL and press Enter . After calibration, the field will revert to DRY, unless an error condition exists.
CALIBRATION VALUE	Reports the value saved when the leak sensor was last calibrated.
LOWER THRESHOLD	Reports the threshold value below which a leak is indicated. This is based on the calibration value.

AD20 Absorbance Detector

C.2.9 Signal Statistics

This screen enables you to monitor the selected input to the A/D circuitry. When the screen is first displayed, the **MAX** and **MIN** status values are equal to the **INPUT** value, and **DURATION** reads 0. Status values are reported in A/D volts and are updated dynamically.

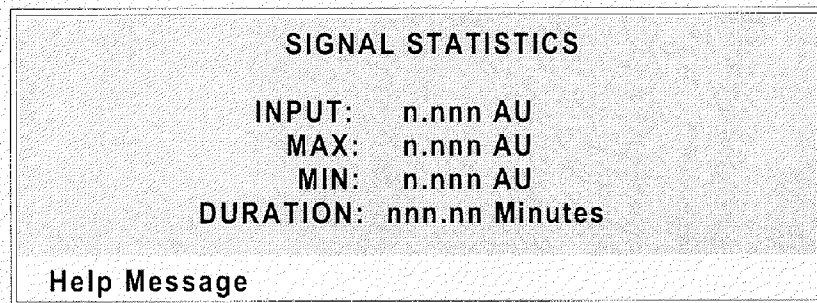

Figure C-17. Signal Statistics Screen

INPUT	The measured data from the cell.
MAX	The maximum input data value during the duration of the test. This value is updated every 100 milliseconds. To reset this to the current INPUT value, press the Reset button.
MIN	The minimum input data value during the duration of the test. This value is updated every 100 milliseconds. To reset this to the current INPUT value, press the Reset button.
DURATION	The duration (in minutes) of the test. The test starts when you display this screen and terminates when you exit.

C.2.10 Offset Zero Calibration

This screen enables you to calibrate the detector zero offset.

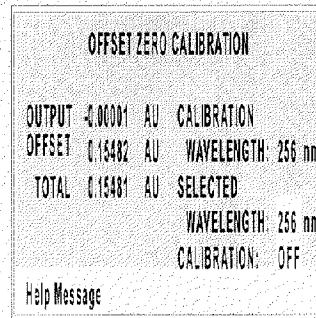

Figure C-18. Offset Zero Calibration Screen

OUTPUT	Reports the measured signal minus the zero offset value.
OFFSET	Reports the zero offset value measured during calibration.
TOTAL	Reports the measured signal from the cell.
CALIBRATION WAVELENGTH	Reports the recorded wavelength measured when the zero offset was last initialized.
SELECTED WAVELENGTH	Enter or change the currently selected wavelength.
CALIBRATION	Select CAL and press Enter to calibrate the zero offset value. Select ON and press Enter to enable the use of the zero offset value. The value will be subtracted from the measured value from the cell. Select OFF to disable the zero offset value.

AD20 Absorbance Detector

D • Common Mobile Phases

AD20 Absorbance Detector

D • Common Mobile Phases

D.1 Properties of Common Mobile Phases

The composition of a mobile phase affects its UV cutoff. In general, ion chromatography eluents are mixtures of water and salts such as Na_2CO_3 , NaOH , or HCl . They may also contain acetonitrile or methanol. Hexane sulfonic acid and tetrabutylammonium hydroxide are also used for some applications. The UV cutoffs of these solvents may differ from those predicted by Table D-1 on the following page. The cutoffs listed in the table apply to spectro-quality grade solvents.

AD20 Absorbance Detector

Solvent	UV Cutoff (nm)	Refractive Index	Selectivity Group
Acetic acid	208	1.370	IV
Acetone	330	1.356	VIa
Acetonitrile	190	1.341	VIb
Dioxane	215	1.420	VIa
Ethanol	210	1.359	II
Hexane sulfonic acid (0.005 M)	230		
Isopropyl	205	1.384	II
Methanol	205	1.326	II
Octane sulfonic acid	230		
Sodium carbonate (0.01 M)	210		
Sodium hydroxide (0.1 M)	217		
Tetrabutylammonium hydroxide (0.005 M)	215		
Tetrapropylammonium hydroxide	195		
Tetrahydrofuran	212	1.405	III
n-Hexane	190	1.372	VII
Toluene	285	1.494	VII
Methylene chloride	233	1.421	V
Triethylamine		1.398	I
Ethyl acetate	256	1.370	VIa
Water		1.333	VIII

Table D-1. Properties of Common Mobile Phases

A

- AD20 Absorbance Detector
 - Control by/of another instrument, 3-13
 - Dimensions, A-3
 - Height in units, B-4
 - Lifting requirements, B-5
 - Manual conventions, 1-4
 - Operating features, 1-3
 - Replacement parts, 5-3
 - Securing to DX 500 modules, B-4
 - Self-diagnostics, 3-5
 - Shipping requirements, B-6
 - Shutdown procedure, 3-14
 - Specifications, A-3, A-5
 - Theory of operation, 2-21
 - Time in use, C-16
 - Unpacking instructions, B-5
 - Weight, A-3
- Analog output settings, A-3
- Analog test points, C-17
- Arrow buttons, 2-5, 2-8
- Asterisk, C-10, C-23
- Autozero, 4-7

B

- Battery, lithium, 3-14
- Beep
 - Invalid entry, C-11
 - Keypad, 2-5, C-11
 - Wavelength calibration test, C-15
- Beer-Lamberts Law, 2-21
- BIOS, 2-13
 - Revision number, 3-6, C-15
- Blank card, 2-12
- Bolts, shipping, B-5

C

- Cable connections
 - Routing, 2-10
- Cable, DX LAN, 4-8
 - Extension cable, B-13
 - Installation, B-12
 - Specifications, C-19
 - Terminator plugs, 4-8
- Campbell, Ian D., 2-22
- Cards
 - Location, 2-10
 - See also* Name of card
 - Servicing of, 2-10
- Cell, 2-14
 - Air bubble removal, 5-4
 - Backpressure line, 5-4, B-8
 - Backpressure regulator, 5-4, B-8
 - Cleaning procedure, 5-3
 - Cleaning the window, B-7
 - Operating pressure, 2-14
 - Path length, A-5
 - Prevention of air bubbles, B-8
 - Tubing connections, B-7
 - Volume, A-5
- Circuitry, A/D, C-26
- Columns
 - Cleaning, 4-5
 - Connections to the cell, B-7
 - Connections to the flow cell, B-7
- Control modes, 2-19
 - See* Direct control mode
 - See* Method control mode
- CPU card, 2-13
 - Lithium battery, 3-14
- Cursor buttons, 2-8
- Cursor movement, 2-5, 2-8 - 2-9

AD20 Absorbance Detector

D

- Detection, photometric, 2-22
- Detector interface card, 2-10, 2-13
 - Installation, B-12
- Detector specifications, A-4
- Deuterium lamp, 2-16
 - Calibration, 5-7, C-22
 - Lamp does not light, 4-7
 - Life expectancy, 2-16
 - Output waning, 4-4
 - Replacing, 5-6
 - Testing, C-22
 - Time in use, C-16
 - Warm-up period, 4-4
 - Wavelength range, C-5
- Diagnostic Menu, C-14
- Diagnostic screens, 2-8
- Diagnostics, 4-9
 - Accessing, C-14
 - Power-up, 3-5 - 3-6
- Direct control mode, 2-19, 3-7
 - Selecting, 2-19
- Display
 - Backlight adjustment, C-11
 - Screen contrast, 2-4
- Dwek, Raymond A., 2-22
- DX 500 systems
 - Enclosures, 2-3
 - Installation, 2-3, B-4
 - Manuals, 1-6
 - Stacking, B-4
- DX LAN card, 2-13
- DX LAN network, 2-10
 - Card, 2-13
 - Connector on rear panel, 4-8
 - Error messages, C-19
 - Faulty communication, 4-8
 - Identification number, C-15
 - Installation, B-12
 - Remote operation, 3-13

E

- Electrical specifications, A-3
- Electromagnetic interference (EMI), 2-11 - 2-12
- Electronics, 2-10
 - Repair of, 5-3
- Electrostatic discharge (ESD), 2-10
- Equilibration, system, 4-4 - 4-5
- Errors
 - See* Troubleshooting

F

- Fields
 - Blank, 2-7
 - Reverse video, 2-5
- Fittings, ferrule, 4-4, 5-3
- Flow cell
 - See* Cell
- Front panel, 2-4
 - Adjusting the position, 2-4
- Front panel buttons
 - Description, 2-5 - 2-9
 - Testing, C-21
- Fuses, 2-10, A-3
 - Replacing, 5-4

H

- Heat exchanger, 2-15
 - Backpressure specification, B-9
 - Disposal, 2-15
 - Pressure, 2-15
 - Volume, A-5
- Humidity, operating, A-3

I

- IEC 1010, 1-4
- Installation instructions, B-6
- Installation site, A-3, B-3
- Integrators, 2-17, B-9
 - Analog output setting, C-12

K

Keyboard test, C-21
Keypad, 2-5

L

Lamps, 1-3
 See Deuterium lamp
 See Tungsten lamp
Leak sensor, 2-14
 Current condition, C-25
 Diagnostic test, C-24
 Voltage, C-17
Leak tray, 2-14
Leaks
 Eliminating, 5-3
Liquid leaks, 3-14
Local mode, 2-17
Locked Remote mode, 2-18

M

Maintenance procedures, 3-14
Manual conventions, 1-4
Manuals, DX 500, 1-6
Menu of Screens, C-4
Menu screens
 Overview, C-3
 Selecting options, C-4
Method clock
 Elapsed time, 3-12
Method control
 Changing parameters, 2-20
 Parameters controlled by, 2-19
 Selecting, 2-20, 3-8
Method control mode, 2-19, 3-8
Method steps, 2-20
 Adding, 3-11
 Blank field, 3-9 - 3-10
 Chronological order, 3-11
 Creating, 3-10
 Deleting, 3-11
 Initial conditions, 3-9
 Maximum number, 3-10
 Time 0.0, 3-9
 Time field, 3-9

 Viewing additional steps, 3-10

Methods, 2-5, 3-8

 Adding a step, 3-11
 Changing, 3-10 - 3-11
 Creating, 2-20, 3-9
 Deleting, 3-11
 Deleting a step, 3-11
 Downloading from PeakNet, 2-18
 Editing, 2-20, 3-10 - 3-11
 Editing changes take effect, 2-20
 Number in memory, 2-21
 Parameters controlled by, 2-19
 Programming, 2-20
 Relay control, 3-13
 Running a different method, 3-13
 Running a method, 3-12
 Saving, 3-10
 Saving changes, 3-12
 Step maximum, 3-10
 TTL control, 3-13

Mobile phases

 pH, 3-4
 Preparation, 3-3
 Reservoirs, 3-4
 UV cutoff, D-3

Modes of control

See also Direct control mode
 See also Method control mode

Modes of operation

See Operating modes

Moduleware, 2-13, 4-9

 Revision number, 3-6, C-15

 Updates, 2-13

O

Offset level, C-12

Operating modes, 2-17 - 2-18

Operation

 Automated control, 1-3, 2-18, 3-13

Operational screens, 2-8

Optical chassis, 2-3

 Components, 2-13

 Drawer, 2-13

AD20 Absorbance Detector

P

- Passivation, 3-5, 3-14
- PeakNet Software, 1-3, 2-10, 2-13, 2-18
 - Method downloading, 2-18
 - Method steps, 3-10
- PeakNet Workstation, 3-13
- Photodiode assembly, 2-14
- Photometric detection, 2-21
- PIO card, 2-12
- Polarity, C-12
- Power supply, 2-9
 - Service of, 2-11
 - Status, 2-13
- Power Supply card, 2-11
- Power switch, 2-4
 - Actuator, 2-4
- Power-up diagnostics
 - See also* Diagnostics
- Power-up tests
 - Lamp failure, C-15
 - Wavelength calibration, C-15
- Pre-amp, 2-12
- Printed circuit boards
 - See* Cards
- Problems
 - See* Troubleshooting

R

- Rear panel description, 2-9
- Recorders
 - Analog output setting, C-12
 - Connections, B-9
- Reference intensity, C-17
- Relay card, 2-13
 - Diagnostic test, C-23
- Relay control, 3-13
 - Connections, B-10
- Remote mode, 2-18
- Repair procedures
 - See* Service procedures
- Rise time, C-12
- Run time, C-9

S

- Safety requirements, 1-4
- Sample intensity, C-17
- Screen contrast, 2-4
- Screens
 - Diagnostic, C-3
 - Operational, C-3
- Screens, diagnostic, C-14
- Select buttons, 2-5, 2-8
- Service procedures
 - Cleaning the cell, 5-3
 - Deuterium lamp replacement, 5-6
 - Electronic components, 5-3
 - Fuse replacement, 5-4
 - Removing trapped air from the cell, 5-4
 - Tungsten lamp replacement, 5-7
- Shoe, B-4
- Shutdown procedure, 3-14
- Signal processing card
 - See* SPI card
- SPI card, 2-12, 4-7, C-17 - C-18
- Stainless steel systems, 3-5, 3-14

T

- Temperature, operating, A-3
- Terminator plugs, B-13
- Ties, B-4
- Trace-level analyses, 2-15, 3-4
 - Cell installation, B-8
- Trademarks, 1-2
- Troubleshooting
 - AD20 does not autozero, 4-7
 - Background absorbance high, 4-6
 - Baseline drift, 4-5
 - Baseline noise, 4-4
 - Detector does not respond, 4-3
 - Diagnostic tests, 4-9
 - See also* Diagnostics
 - DX LAN communication, 4-8
 - Lamp does not light, 4-7
 - Peak size, 4-7
 - Wavelength calibration not working, 4-8
- TTL control, 3-13
 - Assigning functions, 2-17, C-13
 - Configuring logic levels, 2-18

Connections, B-10
Tungsten lamp, 2-15
 Calibration, 5-8, C-23
 Lamp does not light, 4-7
 Life expectancy, 2-15 - 2-16
 Output waning, 4-4
 Replacing, 5-7
 Testing, C-23
 Time in use, C-16
 Warm-up period, 4-4
 Wavelength range, C-5

V

Voltage, full-scale, C-12

W

Waste line installation, B-9

Wavelength

 Calibration, 3-5, 4-8

 Calibration test, C-15

 Selection, 3-3, C-5

AD20 Absorbance Detector
